

PLASTIC SURGERY INSTRUMENTS



SURGPRO



if you have any question or are interested in any of the products in this catalog please email info@surgpro.com

Mikroklingen Halter – Mikroklingen
Micro-blade holder – Micro-blades

Porte micro-lames – Micro-lames
Porta para micro-hojas – Micro-hojas
 Porta micro-lame – Micro-lame



1:1



1:1



1:1



1:1



1:1

Fig. 63

SP 7121-03

Fig. 64

SP 7121-04

Fig. 67

SP 7121-07

Fig. 69

SP 7121-09

Mikroklingen – Packung mit 25 Stück *Micro-Spare blade* – *package of 25 pieces Micro-Lame de réchange* – *paquet de 25 pièces Micro-Hoja de cambio* – *paquete de 25 piezas Micro-Lame di ricambio* – confezione da 25 pezzi

135 mm – 5¹/₄

" **SP 7120-13**

Titan *Titanium*

Titan *Titanio*

Titanio



Die abgebildeten Klingen sind steril

The blades on this page are sterile

Les lames de cette page sont stériles

Los hojas de este pagina son esteriles

Le lame illustrate sono sterili



if you have any question or are interested in any of the products in this catalog please email info@surgpro.com

Skalpelli-Griffe
Scalpel handles

Manches de bistouri
Mangos de bisturí
Manici per bisturi



Standard

Fig. 3

SP 7110-03

Standard

Fig. 4

SP 7100-04

Barron

Fig. 3

SP 7113-03

Fig. 3 R

SP 7115-03

Fig. 3 RG

SP 7116-03

Fig. 7K

SP 7110-71

Fig. 7

SP 7110-07



if you have any question or are interested in any of the products in this catalog please email info@surgpro.com

Skalpellklingen | Lames de bistouris
Scalpel blades | Hojas de bisturí
 | Lame per bisturi

! Die abgebildeten Klingen sind steril
The blades on this page are sterile
 Les lames de cette page sont stériles
 Los hojas de este página son esteriles
 Le lame illustrate sono sterili

Packung mit 100 Stück
Package of 100 pieces
 Paquet de 100 pièces
 Paquetes de 100 piezas
 Confezione da 100 pezzi

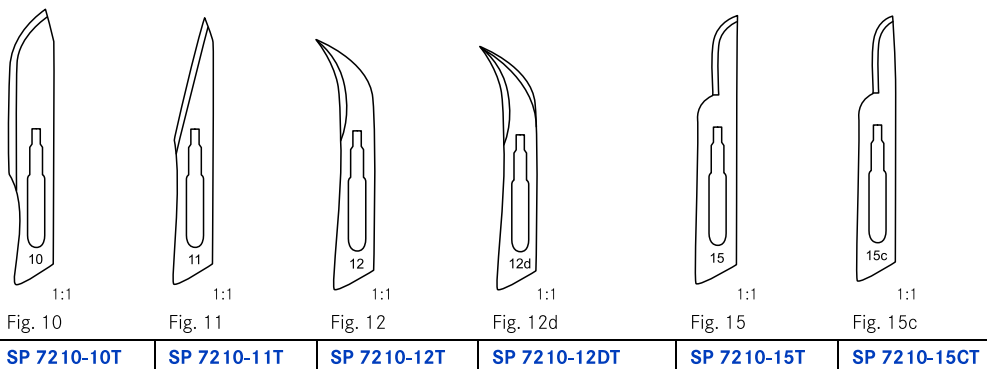

doppelschneidend
double cutting edge
 double tranchante
 corta doble
 a doppio taglio

passend für Griffe: SP 7110-03, SP 7111-03, SP 7110-07, SP 7110-71, SP 7112-03, SP 7113-03, SP 7115-03, SP 7116-03
for handles: SP 7110-03, SP 7111-03, SP 7110-07, SP 7110-71, SP 7112-03, SP7113-03, SP 7115-03, SP 7116-03

pour manches: SP 7110-03, SP 7111-03, SP 7110-07, SP 7110-71, SP 7112-03, SP7113-03, SP 7115-03, SP 7116-03
para mangos: SP 7110-03, SP 7111-03, SP 7110-07, SP 7110-71, SP 7112-03, SP7113-03, SP 7115-03, SP 7116-03

per manici: SP 7110-03, SP 7111-03, SP 7110-07, SP 7110-71, SP 7112-03, SP7113-03, SP 7115-03, SP 7116-03

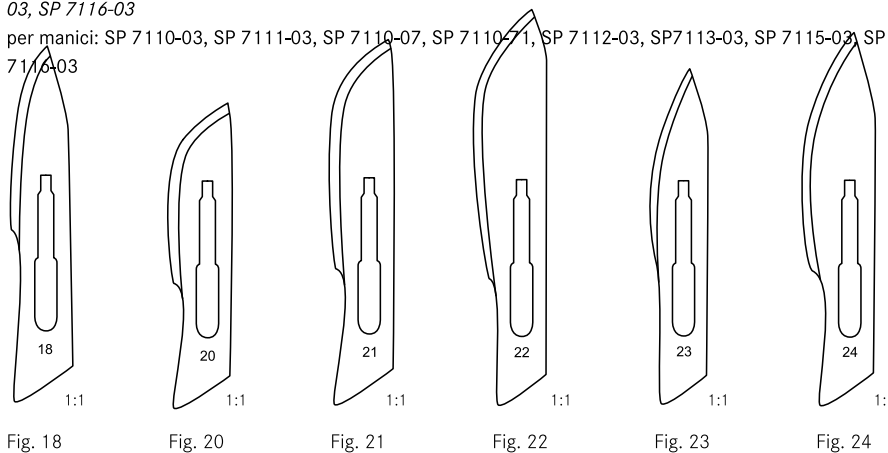

passend für Griffe: SP 7100-04, SP 7101-04, SP 7102-04, SP 7105-08
for handles: SP 7100-04, SP 7101-04, SP 7102-04, SP 7105-08

pour manches: SP 7100-04, SP 7101-04, SP 7102-04, SP 7105-08
para mangos: SP 7100-04, SP 7101-04, SP 7102-04, SP 7105-08
 per manici: SP 7100-04, SP 7101-04, SP 7102-04, SP 7105-08



if you have any question or are interested in any of the products in this catalog please email info@surgpro.com

Dermatome | Dermatomes
Dermatomes | *Dermatomos*
Dermatomi



1:2

Tiersch

200 mm - 8"

SP 7890-20



1:2

Schink

SP 7900-00 300 mm - 12"

komplett mit 1 Klinge und 2 Spannhaltern
complete with 1 blade and 2 plates
complet avec 1 lame et 2 plaques
completo con 1 hoja y 2 placas
completo con 1 lama e 2 placche



1:2

SP 7901-00

Ersatzklinge

spare blade

lame de

rechange *hoja de*

cambio lama di

ricambio



1:2

Schink

SP 7902-00 Spannplatte

Skin fixing plate

Plaque pour tendre la peau

Placa para extender la piel

Placca per stendere la pelle



if you have any question or are interested in any of the products in this catalog please email info@surgpro.com

Dermatome
Dermatomes

Dermatomes
Dermatomos
Dermatomi



Hu m b y

310 mm - 12 1/4 "

SP 7905-00

komplett mit 1 Klinge
complete with 1 blade
complet avec 1 lame
completo con 1 hoja
completo con 1 lama



SP 7908-00

Ersatzklinge für SP7905-00, SP7907-00
spare blade for SP7905-00, SP7907-00
lame de rechange pour SP7905-00,
SP7907-00 *hoja de cambio para SP7905-00, SP7907-00* lama di ricambio par
SP7905-00, SP7907-00



Wat s o n

300 mm - 12 "

SP 7907-00

komplett mit 1 Klinge, Stange starr
complete with 1 blade, fixed bar
complet avec 1 lame, tige fixe
completo con 1 hoja, barra fija
completo con 1 lama, barra fissa



if you have any question or are interested in any of the products in this catalog please email info@surgpro.com

Messinstrumente | Instruments à mesurer
Measuring instruments | Instrumentos de medida
 Strumenti per la misurazione



Ø = 32 mm	Ø = 37 mm	Ø = 43 mm
SP 4664-01	SP 4664-02	SP 4664-03

Mamillenringe (stumpf)
Areola markers (blunt)
 Marqueurs pour l'aréole (mousses)
 Marcadores para aréola (romos)
 Marcatori per areola (smussati)



Freeman					
F = 34 mm	Ø = 36 mm	Ø = 38 mm	Ø = 42 mm	Ø = 45 mm	Ø = 50 mm
SP 4664-04	SP 4664-05	SP 4664-06	SP 4664-07	SP 4664-08	SP 4664-09

Mamillenringe (stumpf)
Areola markers (blunt)
 Marqueurs pour l'aréole (mousses)
 Marcadores para aréola (romos)
 Marcatori per areola (smussati)



Chang	
C = 38/42 mm	
SP 4664-10	

Mamillenring (stumpf)
Areola marker (blunt)
 Marqueur pour l'aréole (mousses)
 Marcador para aréola (romos)
 Marcatore per areola (smussati)



Grossman	
G = 48/52 mm	
SP 4664-11	

Mamillenring (stumpf)
Areola marker (blunt)
 Marqueur pour l'aréole (mousses)
 Marcador para aréola (romos)
 Marcatore per areola (smussati)

Für präzises Markieren der Brustwarze bei:

- kombinierter Bruststraffung
- Verkleinerung des Brustwarzenhofes

For precise marking of the nipple during:

- combined breast-lifting
- reduction of the areola

Pour marquage exact du mamelon en cas de:

- lifting des seins combiné
- réduction de l'aréole

Para la marcación precisa del pezón en caso de:

- combinación con un lifting de la mama
- reducción del tamaño de la areola mamaria

Per la marcatura esatta del capezzolo in caso di:

- rassodamento combinato della mammella
- riduzione del complesso areola-capezzolo



100 mm - 4 "	SP 4651-10 SP
150 mm - 6 "	4 6 5 1 - 1 5 SP
200 mm - 8 "	4 6 5 1 - 2 0 SP
300 mm - 12 "	4 6 5 1 - 3 0 SP
500 mm - 20 "	4651-50



if you have any question or are interested in any of the products in this catalog please email info@surgpro.com

Bleihände | Mains en plomb
Leadhands | *Manos de plomo*
Mano di piombo



1:3

SP 48180-01

für Kinder
child size pour
enfants *para*
niños per
bambini

SP 48180-02

für Erwachsene *adult*
size
pour adultes *para adultos*
per adulti



1:3

SP 48180-03

für Erwachsene, mit Silikonüberzug
adult size with silicone coating
pour adultes, avec couche de
silicone *para adultos, con cubierta de*
silicon per adulti, rivestito di silicone

SP 48180-04

für Kinder, mit Silikonüberzug
child size with silicone coating
pour enfants, avec couche de silicone
para niños, con cubierta de silicon
per bambini, rivestito di silicone



if you have any question or are interested in any of the products in this catalog please email info@surgpro.com

Information technique
Información técnica
Informazione tecnica

Standard Cut

Hochwertige Scheren mit Standardschliff

High performance scissors with standard cutting edges

Ciseaux de haute qualité avec coupe standard

Tijeras de alta calidad con afiladura estándar

Forbici di altissima qualità con filettatura standard



SuperCut

Osteotomschliff und Mikroverzahnung

Präzises Präparieren und minimal traumatisierender Schnitt

Osteotom edges and micro serration

Precise dissection and minimal traumatizing cut

Coupe ostéotome et dentelure micro Dissection précise et minimal traumatisante

Corte osteotomo y dentado micro Dissección precisa mínima traumática

Affilatura a forma di osteotomo e dentellatura micro Dissezione precisa e taglio minimamente traumatizzante



TC Cut

Eingeschweisste Hartmetallschneiden mit Standardschliff
Lange Schnitthaltigkeit

Welded tungsten-carbide cutting edges Long lasting cutting ability

Plaques en carbure de tungstène soudées dans les lames
Qualité de coupe continue

Placas de carburo de tungsteno soldadas en las hojas Calidad de corte permanente

Lame saldate al carburo di tungsteno con filettatura standard
rata di taglio



if you have any question or are interested in any of the products in this catalog please email info@surgpro.com

Information technique
Información técnica
Informazione tecnica

TC SuperCut

Eingeschweisste Hartmetallschneiden, Osteotomschliff und Mikroverzahnung
Lange Schnitthaltigkeit, präzises Präparieren und minimal traumatisierender Schnitt

*Welded tungsten-carbide cutting edges, osteotom edges and micro serration
Long lasting cutting ability, precise dissection and minimal traumatizing cut*

Plaques en carbure de tungstène, coupe ostéotome et dentelure micro
Qualité de coupe continue, dissection précise et minimal traumatisante

*Placas de carburo de tungsteno, corte osteotomo y dentado micro
Calidad de corte permanente, dissección precisa mínima traumática*

Lame saldate al carburo di tungsteno con affilatura a forma di osteotomo e dentellatura micro
Lunga durata di taglio, dissezione precisa e taglio minimamente traumatizzante



Ceramic SuperCut

Eingeschweisste Hartmetallschneide mit Osteotomschliff und Mikroverzahnung, schwarze Keramikbeschichtung
Lange Schnitthaltigkeit durch hohe Oberflächenhärte der Beschichtung, blendfreie Oberfläche, präzises Präparieren und minimal traumatisierender Schnitt

*Welded tungsten-carbide cutting edges with osteotom edges and micro serration, black ceramic coating
Long lasting cutting ability due to high surface hardness of the coating, anti-glaring surface, better vision, precise dissection and minimal traumatizing cut*

Plaques en carbure de tungstène, coupe ostéotome et dentelure micro, surface céramisée
Qualité de coupe continue, dissection précise et minimal traumatisante, surface anti-éblouissante

*Placas de carburo de tungsteno, corte osteotomo y dentado micro, superficie cerámica
Calidad de corte permanente, dissección precisa mínima traumática, superficie antideslumbrante*

Lame saldate al carburo di tungsteno con affilatura a forma di osteotomo e dentellatura micro, rivestimento di ceramica.
Lunga durata di taglio grazie all'alta durezza della superficie. Superficie
essendo, dissezione precisa e taglio minimamente traumatizzante



if you have any question or are interested in any of the products in this catalog please email info@surgpro.com

Scheren | Ciseaux
 Scissors | Tijeras
 Forbici



Metzenbaum

STANDARD		
140 mm – 5½ "	SP 8323-14-A	SP 8333-14-A
150 mm – 6 "		SP 8353-15-A
180 mm – 8 "	SP 8343-18-A	SP 8353-18-A
200 mm – 8 "	SP 8343-20-A	SP 8353-20-A
230 mm – 9 "		SP 8353-23-A
SUPERCUT		
140 mm – 5½ "	SP 8323-14-B	SP 8333-14-B
150 mm – 6 "		SP 8353-15-B
180 mm – 8 "	SP 8343-18-B	SP 8353-18-B
200 mm – 8 "	SP 8343-20-B	SP 8353-20-B
230 mm – 9 "		SP 8353-23-B
TC CUT		
140 mm – 5½ "	SP 8323-14-	SP 8333-14-C
" 180 mm – 8 "	C SP 8343-	SP 8353-18-C
200 mm – 8 "	18-C SP	SP 8353-20-C
230 mm – 9 "	8343-20-C	SP 8353-23-C
CERAMIC SUPERCUT		
140 mm – 5½ "	SP 8323-14-	SP 8333-14-E
180 mm – 8 "	E SP 8343-	SP 8353-18-E
200 mm – 8 "	18-E SP	SP 8353-20-E
230 mm – 9 "	8343-20-E	SP 8353-23-E
250 mm – 9¾ "		SP 8353-25-E



if you have any question or are interested in any of the products in this catalog please email info@surgpro.com

Scheren | Ciseaux
 Scissors | Tijeras
 | Forbici



1:1

Metzenbaum Fino

<input type="checkbox"/> STANDARD 140 mm	
- 5½ " 180 mm - 8 "	SP 8373-14-A
200 mm - 8 "	SP 8381-18-A
	SP 8381-20-A
<input checked="" type="checkbox"/> SUPERCUT	
140 mm - 5½ "	SP 8373-14-B
180 mm - 8 "	SP 8381-18-B
200 mm - 8 "	SP 8381-20-B
<input checked="" type="checkbox"/> TC CUT	
140 mm - 5½ "	SP 8373-14-C
" 180 mm - 8 "	SP 8381-18-C
200 mm - 8 "	SP 8381-20-C
<input checked="" type="checkbox"/> TC SUPERCUT	
180 mm - 8 "	SP 8381-18-D
<input checked="" type="checkbox"/> CERAMIC SUPERCUT	
140 mm - 5½ "	SP 8373-14-E
180 mm - 8 "	SP 8381-18-E
200 mm - 8 "	SP 8381-20-E



1:2



1:1

Baby Metzenbaum

<input type="checkbox"/> STANDARD 115 mm - 4½ "	SP 8333-11-A
<input checked="" type="checkbox"/> SUPERCUT	
115 mm - 4½ "	SP 8333-11-B
<input checked="" type="checkbox"/> TC CUT	
115 mm - 4½ "	SP 8333-11-C
<input checked="" type="checkbox"/> TC SUPERCUT	
115 mm - 4½ "	SP 8333-11-D
<input checked="" type="checkbox"/> CERAMIC SUPERCUT	
115 mm - 4½ "	SP 8333-11-E



if you have any question or are interested in any of the products in this catalog please email info@surgpro.com

Scheren | Ciseaux
 Scissors | Tijeras
 Forbici



1:2



1:1

Lexer

<input type="checkbox"/> STANDARD	
160 mm – 6¼ "	SP 8123-16-A
<input checked="" type="checkbox"/> SUPERCUT	
160 mm – 6¼ "	SP 8123-16-B
<input checked="" type="checkbox"/> TC CUT	
160 mm – 6¼ "	SP 8123-16-C
<input checked="" type="checkbox"/> TC SUPERCUT	
160 mm – 6¼ "	SP 8123-16-D
<input checked="" type="checkbox"/> CERAMIC SUPERCUT	
160 mm – 6¼ "	SP 8123-16-E



1:2



1:1

Mayo Lexer

<input checked="" type="checkbox"/> TC CUT 165	
mm – 6½ "	SP 8125-16-C
<input checked="" type="checkbox"/> TC SUPERCUT	
165 mm – 6½ "	SP 8125-16-D
<input checked="" type="checkbox"/> CERAMIC SUPERCUT	
165 mm – 6½ "	SP 8125-16-E



if you have any question or are interested in any of the products in this catalog please email info@surgpro.com

Scheren | Ciseaux
 Scissors | Tijeras
 Forbici



1:2



1:1

Mayo Stille

<input type="checkbox"/> STANDARD	
170 mm - 6¾"	SP 8283-17-A
<input checked="" type="checkbox"/> SUPERCUT	
170 mm - 6¾"	SP 8283-17-B
<input checked="" type="checkbox"/> TC CUT	
170 mm - 6¾"	SP 8283-17-C
<input checked="" type="checkbox"/> TC SUPERCUT	
170 mm - 6¾"	SP 8283-17-D
<input checked="" type="checkbox"/> CERAMIC SUPERCUT	
170 mm - 6¾"	SP 8283-17-E



1:1

Reynolds

<input type="checkbox"/> STANDARD	
140 mm - 5½"	SP 8603-14-A
160 mm - 6¼"	SP 8603-16-A
<input checked="" type="checkbox"/> CERAMIC SUPERCUT	
160 mm - 6¼"	SP 8603-16-E



if you have any question or are interested in any of the products in this catalog please email info@surgpro.com

Scheren | Ciseaux
 Scissors | Tijeras
 Forbici



1:2

Joseph

<input type="checkbox"/> STANDARD	
150 mm – 6 "	SP 8693-14-A
<input type="checkbox"/> SUPERCUT	
150 mm – 6 "	SP 8693-14-B



1:1



1:2

Kelly

<input type="checkbox"/> STANDARD	
160 mm – 6¼ "	SP 8463-16-A
<input type="checkbox"/> SUPERCUT	
160 mm – 6¼ "	SP 8463-16-B
<input type="checkbox"/> TC CUT	
160 mm – 6¼ "	SP 8463-16-C
<input type="checkbox"/> TC SUPERCUT	
160 mm – 6¼ "	SP 8463-16-D
<input type="checkbox"/> CERAMIC SUPERCUT	
160 mm – 6¼ "	SP 8463-16-E



1:1



if you have any question or are interested in any of the products in this catalog please email info@surgpro.com

Scheren | Ciseaux
 Scissors | Tijeras
 | Forbici



1:2



1:1

Stevens

<input type="checkbox"/> STANDARD	
130 mm - 5 "	SP 8463-13-A
<input checked="" type="checkbox"/> SUPERCUT	
130 mm - 5 "	SP 8463-13-B

stumpf blunt
mousses roma
smusse



1:2



1:1

Iris

<input checked="" type="checkbox"/> SUPERCUT	
115 mm - 4½ "	SP 9434-11-B
<input checked="" type="checkbox"/> TC SUPERCUT	
115 mm - 4½ "	SP 9434-11-C

spitz sharp
pointue aguda
acuta



if you have any question or are interested in any of the products in this catalog please email info@surgpro.com

Technische Informationen | Information technique
Technical information | *Información técnica*
 | *Informazione tecnica*

140 mm – 5½"	SP 8198-14	SP 9198-14
140 mm – 5½"	SP 8198-14 SU	SP 9198-14 SU
140 mm – 5½"	SP 8198-14 SUB	SP 9198-14 SUB
140 mm – 5½"	SP 8193-14 TC	SP 9193-14 TC
140 mm – 5½"	SP 8197-14 SU TC	SP 9197-14 SU TC
	gerade straight droits	gebogen curved courbes



standard

Scheren aus rostfreiem Stahl mit Standardschliff für präzises Arbeiten.

Stainless steel scissors with standard cut for precise working.

Ciseaux d'acier inoxydable avec coupe standard pour des travaux précis.

Tijeras de acero inoxidable con corte standard para un trabajo preciso.

Forbici di acciaio inossidabile con fi lattura Standard per tagli precisi.

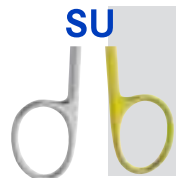

SU

super cut

Messerschliff und Mikroverzahnung für einen feinen minimal traumatisierenden Schnitt.

Knife edges and micro serration for a fine and minimally traumatizing cut.

Aiguisement tranchante et dents micro pour une coupe fine, peu traumatisante.

Hoja de bisturí y dentadura micro para un corte fino, mínimo traumatizante.

Affilatura a scalpello e dentellatura micro per uno taglio fine, minimo traumatizzante.



SUB

super cut

SuperCut Scheren mit schwarzen Griffen.

SuperCut scissors with black handles.

Ciseaux SuperCut avec anneaux noirs

Tijeras SuperCut con anillos negros

Forbici SuperCut con anelli neri

black handle

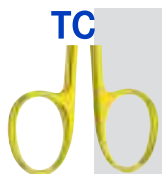

TC

tungsten carbide

Nahtlos aufgeschweisste, korrosionsfreie Hartmetallschneiden.

Seamless welded, corrosion-free tungsten carbide cutting edges.

Plaques en carbure de tungstène, non-corrosives, soudées homogènement dans les lames.

Placas de carburo de tungsteno soldadas homogéneamente y anticorrosiva en las hojas.

Congiunzione omogenea senza cordolo lame saldate al carburo di tungsteno.



SU TC

super cut

Nahtlos aufgeschweisste Hartmetallschneide mit Messerschliff und Mikroverzahnung

Tungsten carbide plates, seamlessly welded into the jaws. Knife edges and micro serration.

Plaques en carbure de tungstène, soudées homogènement das les lames. Aiguisement trachante et dents micro.

Placas de carburo de tungsteno soldadas homogéneamente y en las hojas. Hoja de bisturí y dentura micro.

Lame con taglio in tungsteno, senza saldature del morso, con taglio delle lame e dentatura micro.

if you have any question or are interested in any of the products in this catalog please email info@surgpro.com



Chirurgische Scheren
Operating scissors

Ciseaux à chirurgie
Tijeras para cirugía
Forbici per chirurgia



Mayo

145 mm - 5 ³ / ₄ "	SP 8272-14	SP 8273-14
150 mm - 6 ³ / ₄ "	SP 8272-15	SP 8273-15
170 mm - 6 ³ / ₄ "	SP 8272-17	SP 8273-17
230 mm - 9 "	SP 8272-23	SP 8273-23
145 mm - 5 ³ / ₄ "	SP 8272-14 SU	SP 8273-14 SU
150 mm - 6 ³ / ₄ "	SP 8272-15 SU	SP 8273-15 SU
170 mm - 6 ³ / ₄ "	SP 8272-17 SU	SP 8273-17 SU
230 mm - 9 "	SP 8272-23 SU	SP 8273-23 SU
145 mm - 5 ³ / ₄ "	SP 8272-14 SUB	SP 8273-14 SUB
150 mm - 6 ³ / ₄ "	SP 8272-15 SUB	SP 8273-15 SUB
170 mm - 6 ³ / ₄ "	SP 8272-17 SUB	SP 8273-17 SUB
230 mm - 9 "	SP 8272-23 SUB	SP 8273-23 SUB
145 mm - 5 ³ / ₄ "	SP 8278-14 TC	SP 8279-14 TC
170 mm - 6 ³ / ₄ "	SP 8278-17 TC	SP 8279-17 TC
230 mm - 9 "	SP 8278-23 TC	SP 8279-23 TC



if you have any question or are interested in any of the products in this catalog please email info@surgpro.com

Chirurgische Scheren | Ciseaux à chirurgie
Operating scissors | *Tijeras para cirugía*
 Forbici per chirurgia



Fig. 1



Fig. 2



Fig. 3

120 mm - 4 ³ / ₄ "	SP 8523-12	SP 8524-12	SP 8525-12
--	-------------------	-------------------	-------------------



Fig. 1



Fig. 2



Fig. 3

120 mm - 4 ³ / ₄ "	SP 8533-12	SP 8534-12	SP 8535-12
--	-------------------	-------------------	-------------------



if you have any question or are interested in any of the products in this catalog please email info@surgpro.com

Chirurgische Scheren
Operating scissors

Ciseaux à chirurgie
Tijeras para cirugía
Forbici per chirurgia



Lexer

160 mm - 6 ¹ / ₄ "	SP 8122-16	SP 8123-16
210 mm - 8 ¹ / ₄ "	SP 8122-21	SP 8123-21

160 mm - 6 ¹ / ₄ "	SP 8122-16 SU	SP 8123-16 SU
--	----------------------	----------------------

160 mm - 6 ¹ / ₄ "	SP 8122-16 SUB	SP 8123-16 SUB
--	-----------------------	-----------------------

160 mm - 6 ¹ / ₄ "	SP 8138-16 TC	SP 8139-16 TC
--	----------------------	----------------------

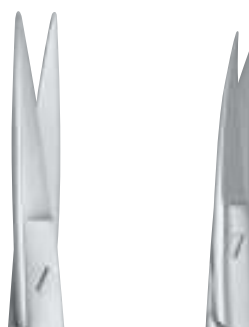

Kelly

160 mm - 6 ¹ / ₄ "	SP 8462-16	SP 8463-16
180 mm - 7"	SP 8462-18	SP 8463-18

Fistel Scheren

Fistula scissors

Ciseaux pour fi stules

Tijeras para fi stulas

Forbici per fi stole



if you have any question or are interested in any of the products in this catalog please email info@surgpro.com

Chirurgische Scheren | Ciseaux à chirurgie
Operating scissors | *Tijeras para cirugía*
 Forbici per chirurgia



1:2



1:1



1:1

Peck - Jos

ef	SP 8198-14	SP 9198-14
140 mm - 5 1/2"		
"	SP 8198-14 SU	SP 9198-14 SU
140 mm - 5 1/2"		
140 mm - 5 1/2"	SP 8198-14 SUB	SP 9198-14 SUB
140 mm - 5 1/2"	SP 8193-14 TC	SP 9193-14 TC
140 mm - 5 1/2"	SP 8197-14 SU TC	SP 9197-14 SU TC



1:2



1:1



1:1

Brophy (Sullivan)

145 mm - 5 7/8"	SP 8572-14	SP 8573-14
-----------------	-------------------	-------------------



if you have any question or are interested in any of the products in this catalog please email info@surgpro.com

Chirurgische Scheren – Präparierscheren
Operating scissors – Dissecting scissors

Ciseaux à chirurgie – Ciseaux à dissection
Tijeras para cirugía – Tijeras de disección
 Forbici per chirurgia – Forbici per dissezione



Metzenbaum-Nels

mm	Fig. 1	Fig. 2	Fig. 3
115 mm – 4 ¹ / ₂ "	SP 8323-11		
145 mm – 5 ³ / ₄ "	SP 8323-14	SP 8324-14	SP 8325-14
150 mm – 6 "	SP 8343-15		
180 mm – 7 "	SP 8343-18	SP 8344-18	SP 8345-18
200 mm – 8 "	SP 8343-20	SP 8344-20	SP 8345-20
230 mm – 9 "	SP 8343-23	SP 8344-23	SP 8345-23
250 mm – 9 ³ / ₄ "	SP 8343-25	SP 8344-25	SP 8345-25
280 mm – 11 "	SP 8343-28	SP 8344-28	SP 8345-28
300 mm – 12 "	SP 8343-30	SP 8344-30	SP 8345-30
8343-23 SU			
145 mm – 5 ³ / ₄ "	SP 8323-14 SU		
180 mm – 7 "	SP 8343-18		
200 mm – 8 "	SU SP 8343-		
230 mm – 9 "	20 SU SP		
8343-23 SUB			
145 mm – 5 ³ / ₄ "	SP 8323-14 SUB		
180 mm – 7 "	SP 8343-18		
200 mm – 8 "	SUB SP 8343-		
230 mm – 9 "	20 SUB SP		
8343-23 SUB			
115 mm – 4 ¹ / ₂ "	SP 8327-11 TC		
145 mm – 5 ³ / ₄ "	SP 8327-14 TC	SP 8328-14 TC	SP 8329-14 TC
180 mm – 7 "	SP 8347-18 TC	SP 8348-18	SP 8349-18
200 mm – 8 "	SP 8347-20 TC	TC SP 8348-	TC SP 8349-
230 mm – 9 "	SP 8347-23 TC	20 TC SP	20 TC SP
250 mm – 9 ³ / ₄ "	SP 8347-25 TC	8348-23 TC	8349-23 TC
280 mm – 11 "	SP 8347-28 TC		
300 mm – 12 "	SP 8347-30 TC		



if you have any question or are interested in any of the products in this catalog please email info@surgpro.com

Chirurgische Scheren – Präparierscheren
Operating scissors – Dissecting scissors

Ciseaux à chirurgie – Ciseaux à dissection
Tijeras para cirugía – Tijeras de disección
 Forbici per chirurgia – Forbici per dissezione



Metzenbaum-Nels

mm in	Fig. 1	Fig. 2	Fig. 3
115 mm – 4 ¹ / ₂ "	SP 8333-11		
145 mm – 5 ³ / ₄ "	SP 8333-14	SP 8334-14	SP 8335-14
150 mm – 6 "	SP 8353-15		
180 mm – 7 "	SP 8353-18	SP 8354-18	SP 8356-18
200 mm – 8 "	SP 8353-20	SP 8354-20	SP 8356-20
230 mm – 9 "	SP 8353-23	SP 8354-23	SP 8356-23
250 mm – 9 ³ / ₄ "	SP 8353-25	SP 8354-25	SP 8356-25
280 mm – 11 "	SP 8353-28	SP 8354-28	SP 8356-28
300 mm – 12 "	SP 8353-30	SP 8354-30	SP 8356-30
145 mm – 5 ³ / ₄ "	SP 8333-14 SU		
180 mm – 7 "	SP 8353-18 SU		
200 mm – 8 "	SP 8353-20 SU		
230 mm – 9 "	SP 8353-23 SU		
145 mm – 5 ³ / ₄ "	SP 8333-14 SUB		
180 mm – 7 "	SP 8353-18 SUB		
200 mm – 8 "	SP 8353-20 SUB		
230 mm – 9 "	SP 8353-23 SUB		
115 mm – 4 ¹ / ₂ "	SP 8337-11 TC		
145 mm – 5 ³ / ₄ "	SP 8337-14 TC	SP 8338-14 TC	SP 8339-14 TC
180 mm – 7 "	SP 8357-18 TC	SP 8358-18 TC	SP 8359-18 TC
200 mm – 8 "	SP 8357-20 TC	SP 8358-20 TC	SP 8359-20 TC
230 mm – 9 "	SP 8357-23 TC	SP 8358-23 TC	SP 8359-23 TC
250 mm – 9 ³ / ₄ "	SP 8357-25 TC		
280 mm – 11 "	SP 8357-28 TC		
300 mm – 12 "	SP 8357-30 TC		



if you have any question or are interested in any of the products in this catalog please email info@surgpro.com

Chirurgische Scheren – Präparierscheren
Operating scissors – Dissecting scissors

Ciseaux à chirurgie – Ciseaux à dissection
Tijeras para cirugía – Tijeras de disección
 Forbici per chirurgia – Forbici per dissezione



Metzenbaum-Fino

	Fig. 1	Fig. 3	Fig. 1	Fig. 3
145 mm – 5 ³ / ₄ "	SP 8372-14	SP 8374-14	SP 8373-14	SP 8375-14
180 mm – 7 "	SP 8380-18		SP 8381-18 SP	
200 mm – 8 "	SP 8380-20		8381-20 SP	
230 mm – 9 "	SP 8380-23		8381-23	
<hr/>				
145 mm – 5 ³ / ₄ "	SP 8372-14 SU		SP 8373-14 SU	
180 mm – 7 "	SP 8380-18 SU		SP 8381-18 SU	
200 mm – 8 "	SP 8380-20 SU		SP 8381-20 SU	
230 mm – 9 "	SP 8380-23 SU		SP 8381-23 SU	
<hr/>				
145 mm – 5 ³ / ₄ "	SP 8372-14 SUB		SP 8373-14 SUB	
180 mm – 7 "	SP 8380-18 SUB		SP 8381-18 SUB	
200 mm – 8 "	SP 8380-20 SUB		SP 8381-20 SUB	
230 mm – 9 "	SP 8380-23 SUB		SP 8381-23 SUB	
<hr/>				
145 mm – 5 ³ / ₄ "	SP 8363-14 TC	SP 8366-14 TC	SP 8365-14 TC	SP 8367-14 TC
180 mm – 7 "	SP 8370-18 TC		SP 8371-18 TC	
200 mm – 8 "	SP 8370-20 TC		SP 8371-20 TC	
230 mm – 9 "	SP 8370-23 TC		SP 8371-23 TC	



if you have any question or are interested in any of the products in this catalog please email info@surgpro.com

Irisscheren | Ciseaux à iridectomie
iris scissors | Tijeras para iridectomia
 Forbici per iridectomia

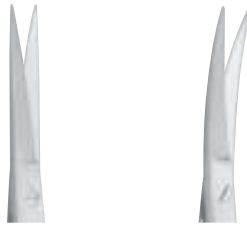

90 mm - 3 1/2 "	SP 8642-09	SP 8643-09
115 mm - 4 1/2 "	SP 8632-11	SP 8633-11
115 mm - 4 1/2 "	SP 8636-11 TC	SP 8637-11 TC



90 mm - 3 1/2 "	SP 8652-09	SP 8653-09
100 mm - 4 "	SP 8652-10	SP 8653-10
115 mm - 4 1/2 "	SP 8652-11	SP 8653-11
100 mm - 4 "	SP 8652-10 SU	SP 8653-10 SU
100 mm - 4 "	SP 8652-10 SUB	SP 8653-10 SUB



if you have any question or are interested in any of the products in this catalog please email info@surgpro.com

Feine Scheren
Fine scissors

Ciseaux fins
Tijeras finas
Forbici fini



1:2



1:1

1:1

Strabismus-Schere

115 mm - 4 1/2 "	SP 9482-11	SP 9483-11
115 mm - 4 1/2 "	SP 9482-11 SU	SP 9483-11 SU
115 mm - 4 1/2 "	SP 9482-11 SUB	SP 9483-11 SUB



1:2

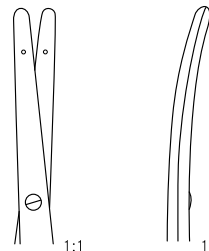

1:1

1:1

Knapp

105 mm - 4 1/4 "

"

SP 8688-10

SP 8689-10

stumpf
blunt
mousse
aguda
smusse



1:2

Gradle

90 mm - 3 3/4 "

SP 8694-09

gebogen, spitz
curved, pointed
courbes, pointue
curva, aguda
curve, acuta



if you have any question or are interested in any of the products in this catalog please email info@surgpro.com

Feine Scheren
Fine scissors

Ciseaux fins
Tijeras finas
Forbici fini



Quinby
125 mm - 5" **SP 8592-12**



1:1



Neumann
120 mm - 4³/₄" **SP 8597-12**

S-förmig gebogen
S curved
courbe en S
curva en S
curve a forma di S

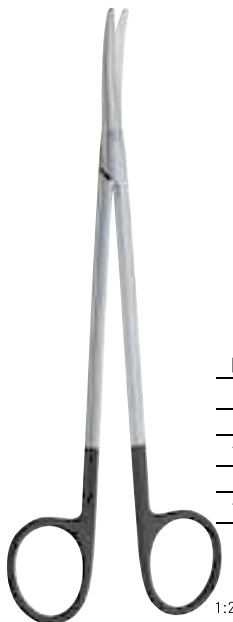

McIndoe
180 mm - 7" **SP 8352-18**
180 mm - 7" **SP 8352-18 SU**
180 mm - 7" **SP 8352-18 SUB**



1:2

Kurzes Maul
Short jaw
Mors court
Boca corta
Taglio corto



Locklin
165 mm - 6¹/₂" **SP 8582-16** **SP 8587-16**

gerade, gezahnt
straight, saw edge
droit, dentelée
recta, dentada
rette, dentate

gebogen, gezahnt
curved, saw edge
courbe, dentelée
curva, dentada
curve, dentate



Feine chirurgische Scheren
Fine operating scissors

Ciseaux fins à chirurgie
Tijeras finas para cirugía
Forbici fine per
chirurgia



Converse

100 mm - 3 3/4"

SP 9203-10

aufgewinkelt
angled
courbe vers le
haut *angulado*
angulato

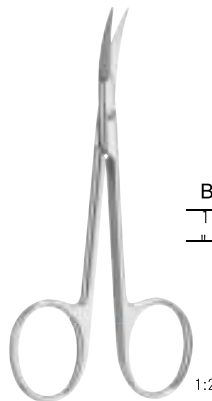

Beuse

115 mm - 5"

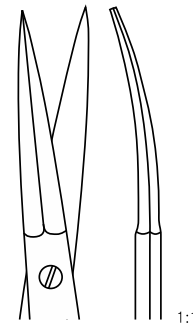

SP 9206-11

leicht gebogen, spitz
slightly curved, pointed
légèrement courbe,
pointues
ligeramente curva, aguda
legeramente curve, acuta

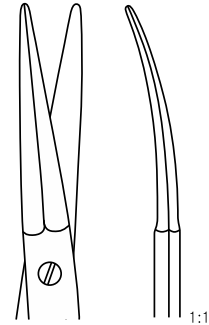

SP 9207-11

leicht gebogen, stumpf
slightly curved, blunt
légèrement courbe,
mousses
ligeramente curva, roma
legeramente curve, smussa



1:1

1:1

Ribbon Stevens

95 mm - 3 3/4"

SP 9456-10

SP 9454-10

spitz - spitz
sharp - sharp
pointue -
pointue *aguda* -
aguda acuta -
acuta



1:1

1:1

Ribbon Stevens

95 mm - 3 3/4"

SP 9457-10

SP 9455-10

stumpf - stumpf
blunt - blunt
mousse -
mousse *roma* -
roma smussa -
smussa



1:2



if you have any question or are interested in any of the products in this catalog please email info@surgpro.com

Sehnscheren | Ciseaux à ténatomie
Tenotomy scissors | *Tijeras para tenotomia*
 Forbici per tenotomia



Stevens

100 mm - 4 "	SP 9452-10	SP 9453-10
110 mm - 4 ¹ / ₄ "	SP 9452-11	SP 9453-11
100 mm - 4 "	SP 9452-10 SU	SP 9453-10 SU
110 mm - 4 ¹ / ₄ "	SP 9452-11 SU	SP 9453-11 SU
100 mm - 4 "	SP 9452-10 SUB	SP 9453-10 SUB
110 mm - 4 ¹ / ₄ "	SP 9452-11 SUB	SP 9453-11 SUB

spitz - spitz
 sharp - sharp
 pointue -
 pointue *aguda* -
aguda acuta -
 acuta



Stevens

100 mm - 4 "	SP 9462-10	SP 9463-10
110 mm - 4 ¹ / ₄ "	SP 9462-11	SP 9463-11
100 mm - 4 "		SP 9463-10 SU
110 mm - 4 ¹ / ₄ "		SP 9463-11 SU
100 mm - 4 "		SP 9463-10 SUB
110 mm - 4 ¹ / ₄ "		SP 9463-11 SUB

stumpf - stumpf
 blunt - blunt
 mousse -
 mousse *roma* -
roma smussa -
 smussa



if you have any question or are interested in any of the products in this catalog please email info@surgpro.com

Scheren für plastische Operationen
Plastic surgery scissors

Ciseaux pour la chirurgie plastique
Tijeras para cirugía plástica
Forbici per chirurgia plastica



Reynolds (Jameson)

160 mm – 6 ¹ / ₄ "	SP 8602-16	SP 8603-16
180 mm – 7 "	SP 8602-18	SP 8603-18
160 mm – 6 ¹ / ₄ "	SP 8602-16 SU	SP 8603-16 SU
180 mm – 7 "	SP 8602-18 SU	SP 8603-18 SU
160 mm – 6 ¹ / ₄ "	SP 8602-16 SUB	SP 8603-16 SUB
180 mm – 7 "	SP 8602-18 SUB	SP 8603-18 SUB



K ilner (Ragnell)

120 mm – 4 ³ / ₄ "	SP 8697-12
150 mm – 6 "	SP 8697-15
120 mm – 4 ³ / ₄ "	SP 8697-12 SU
150 mm – 6 "	SP 8697-15 SU
180 mm – 7 "	SP 8697-18 SU
200 mm – 8 "	SP 8697-20 SU
120 mm – 4 ³ / ₄ "	SP 8697-12 SUB
150 mm – 6 "	SP 8697-15 SUB
180 mm – 7 "	SP 8697-18 SUB
200 mm – 8 "	SP 8697-20 SUB
120 mm – 4 ³ / ₄ "	SP 8698-12 TC
150 mm – 6 "	SP 8698-15 TC



if you have any question or are interested in any of the products in this catalog please email info@surgpro.com

Scheren für plastische Operationen
Plastic surgery scissors

Ciseaux pour la chirurgie plastique
Tijeras para cirugía plástica
Forbici per chirurgia plastica



1:2



1:1



1:1

Joseph

140 mm - 5 1/2 "	SP 8692-14	SP 8693-14
------------------	----------------------------	----------------------------

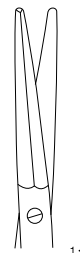

1:2



1:2

Gorney

180 mm - 7 1/4 "	SP 8704-18 SU	SP 8705-18 SU
230 mm - 9 "	SP 8704-23 SU	SP 8705-23 SU

180 mm - 7 1/4 "	SP 8704-18 SUB	SP 8705-18 SUB
230 mm - 9 "	SP 8704-23 SUB	SP 8705-23 SUB

190 mm - 7 1/2 "	SP 8702-20 TC	SP 8703-20 TC
230 mm - 9 "	SP 8702-23 TC	SP 8703-23 TC



if you have any question or are interested in any of the products in this catalog please email info@surgpro.com

Scheren für plastische Operationen
Plastic surgery scissors

Ciseaux pour la chirurgie plastique
Tijeras para cirugía plástica
Forbici per chirurgia plastica

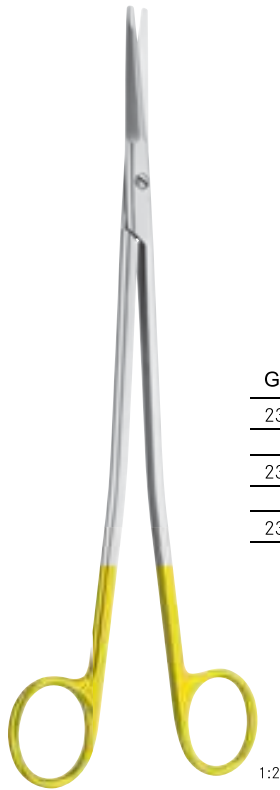

1:2

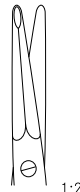

1:2



1:2

Gorney Platysma

230 mm - 9 "	SP 9186-23 SU	SP 9185-23 SU
230 mm - 9 "	SP 9186-23 SUB	SP 9185-23 SUB
230 mm - 9 "	SP 9170-23 TC	SP 9171-23 TC



1:2

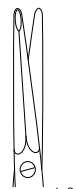

1:2



1:2

Gorney-Freeman

190 mm - 7 1/2 "	SP 9168-19	SP 9167-19
190 mm - 7 1/2 "	SP 9168-19 SU	SP 9169-19 SU
190 mm - 7 1/2 "	SP 9168-19 SUB	SP 9169-19 SUB
190 mm - 7 1/2 "	SP 9170-19 TC	SP 9171-19 TC
190 mm - 7 1/2 "	SP 9172-19 SU TC	SP 9173-19 SU TC



if you have any question or are interested in any of the products in this catalog please email info@surgpro.com

Scheren für plastische Operationen
Plastic surgery scissors

Ciseaux pour la chirurgie plastique
Tijeras para cirugía plástica
Forbici per chirurgia plastica



1:2

Gorney-Delicate

205 mm - 8 ¹ / ₄ "	SP 9 163-20 SU
205 mm - 8 ¹ / ₄ "	SP 9 163-20 SUB
205 mm - 8 ¹ / ₄ "	SP 9 164-20 TC
205 mm - 8 ¹ / ₄ "	SP 9 165-20 SU TC

gebogen
curved
courbe
curva
curve

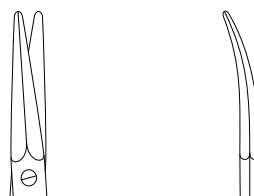

Kaye

145 mm - 5 ³ / ₄ "	SP 9 174-14 SU	SP 9 175-14 SU
185 mm - 7 "	SP 9 174-18 SU	SP 9 175-18 SU
230 mm - 9 "	SP 9 176-23 SU	SP 9 177-23 SU
145 mm - 5 ³ / ₄ "	SP 9 174-14 SUB	SP 9 175-14 SUB
185 mm - 7 "	SP 9 174-18 SUB	SP 9 175-18 SUB
230 mm - 9 "	SP 9 176-23 SUB	SP 9 177-23 SUB
145 mm - 5 ³ / ₄ "	SP 9 174-14 TC	SP 9 175-14 TC
185 mm - 7 "	SP 9 174-18 TC	SP 9 175-18 TC
230 mm - 9 "	SP 9 176-23 TC	SP 9 177-23 TC
145 mm - 5 ³ / ₄ "	SP 9 178-14 SU TC	SP 9 179-14 SU TC
185 mm - 7 "	SP 9 178-18 SU TC	SP 9 179-18 SU TC
230 mm - 9 "	SP 9 178-23 SU TC	SP 9 179-23 SU TC



if you have any question or are interested in any of the products in this catalog please email info@surgpro.com

Scheren für plastische Operationen
Plastic surgery scissors

Ciseaux pour la chirurgie plastique
Tijeras para cirugía plástica
Forbici per chirurgia plastica



1:2

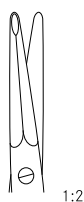

1:2



1:2

Freeman-Kaye

185 mm - 7"	SP 9182-18 SU	SP 9183-18 SU
185 mm - 7"	SP 9182-18 SUB	SP 9183-18 SUB
185 mm - 7"	SP 9172-18 TC	SP 9173-18 TC
185 mm - 7"		SP 9183-18 SU TC



1:2



1:2

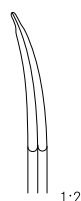

1:2

Aufricht

150 mm - 5 ³ / ₄ "	SP 8706-15 SU	SP 8707-15 SU
"		
150 mm - 5 ³ / ₄ "	SP 8706-15 SUB	SP 8707-15 SUB



if you have any question or are interested in any of the products in this catalog please email info@surgpro.com

Scheren für plastische Operationen
Plastic surgery scissors

Ciseaux pour la chirurgie plastique
Tijeras para cirugía plástica
Forbici per chirurgia plastica

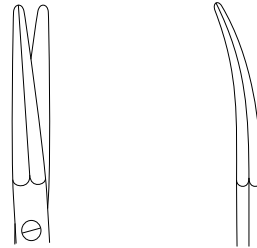

Kahn

145 mm - 5 7/2"	SP 8154-14	SP 8155-14
180 mm - 7"	SP 8154-18	SP 8155-18

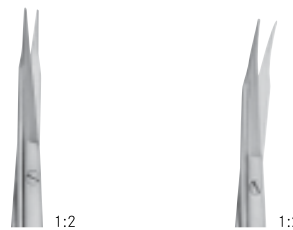

Goldman-Fox

130 mm - 5"	SP 9922-13	SP 9923-13
130 mm - 5"	SP 9922-13 SU	SP 9923-13 SU
130 mm - 5"	SP 9922-13 SUB	SP 9923-13 SUB
130 mm - 5"	SP 9924-13 SU TC	SP 9925-13 SU TC



if you have any question or are interested in any of the products in this catalog please email info@surgpro.com

Face-Lift-Scheren
Face-lift scissors

Ciseaux pour le face-lift
Tijeras para el face-lift
Forbici per "face-lifting"

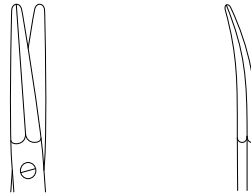

Rees

170 mm - 6 ³ / ₄ "	SP 9182-17	SP 9183-17
205 mm -	SP 9182-20	SP 9183-20
170 mm - 6 ³ / ₄ "	SP 9182-17 SU	SP 9183-17 SU
205 mm -	SP 9182-20 SU	SP 9183-20 SU
170 mm - 6 ³ / ₄ "	SP 9182-17 SUB	SP 9183-17 SUB
205 mm -	SP 9182-20 SUB	SP 9183-20 SUB
170 mm - 6 ³ / ₄ "	SP 9192-17 TC	SP 9193-17 TC
205 mm -	SP 9192-20 TC	SP 9193-20 TC



Rees Bulldog

130 mm - 5"

SP 9199-13

leicht gebogen

slightly curved

légèrement courbe

ligeramente curva

legermente curve

1:2



1:2

Davis

170 mm - 6³/₄" **SP 9191-18**

170 mm - 6³/₄" **SP 9191-18 SU**

170 mm - 6³/₄" **SP 9191-18 SUB**



if you have any question or are interested in any of the products in this catalog please email info@surgpro.com

Face-Lift-Scheren <i>Face-lift scissors</i>	Ciseaux pour le face-lift <i>Tijeras para el face-lift</i> Forbici per "face-lifting"
---	---

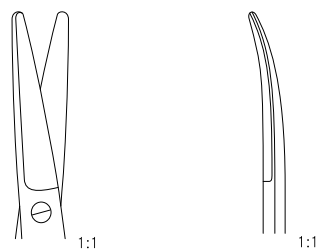

Castanares

160 mm - 6 ¹ / ₄ "	SP 9208-16	SP 9209-16
160 mm - 6 ¹ / ₄ "	SP 9210-16 TC	



Gregory

145 mm - 5 ⁷ / ₂ "	SP 9196-14 TC
--	----------------------

leicht gebogen
slightly curved
 légèrement courbe
ligeramente curva
 legermente curve



if you have any question or are interested in any of the products in this catalog please email info@surgpro.com

Nasenscheren
Nasal scissors

Ciseaux nasaux
Tijeras nasales
Forbici nasali



Knight	
180 mm - 7"	SP 9205-18

gewinkelt
angled
angulée
angulado
angulato

1:2



Fomon	
135 mm - 5 1/4"	SP 8392-14
135 mm - 5 1/4"	SP 8392-14 SU
135 mm - 5 1/4"	SP 8392-14 SUB

stark gebogen
strongly curved
fortement courbe
fuertemente curva
fortamente curve

1:2



Boettcher	
180 mm - 7"	SP 8832-18

1:2



Thorek	
190 mm - 7 1/2"	SP 8394-19

1:2



if you have any question or are interested in any of the products in this catalog please email info@surgpro.com

Augenscheren | Ciseaux pour blépharoplastie
Blepharoplasty scissors | Tijeras para blefaroplastica
 Forbici per blefaroplastica



1:2



1:1



1:1

Shea

120 mm - 4 ³ / ₄ "	SP 9208-12	SP 9209-12
120 mm - 4 ³ / ₄ "	SP 9208-12 SU	SP 9209-12 SU
120 mm - 4 ³ / ₄ "	SP 9208-12 SUB	SP 9209-12 SUB

spitz
 pointed
 pointue
 aguda
 acuta



1:2



1:1



1:1

Bonn

80 mm - 3 ¹ / ₄ "	SP 9211-09	SP 9212-09
---	-------------------	-------------------



if you have any question or are interested in any of the products in this catalog please email info@surgpro.com

Augenscheren
Blepharoplasty scissors

Ciseaux pour blépharoplastie
Tijeras para blefaroplastica
Forbici per blefaroplastica



Par - Type

115 mm - 4 ¹ / ₂ "	SP 8188-11	SP 8189-11
145 mm - 5 ³ / ₄ "	SP 8188-14	SP 8189-14
115 mm - 4 ¹ / ₂ "	SP 8188-11 SU	SP 8189-11 SU
145 mm - 5 ³ / ₄ "	SP 8188-14 SU	SP 8189-14 SU
115 mm - 4 ¹ / ₂ "	SP 8188-11 SUB	SP 8189-11 SUB
145 mm - 5 ³ / ₄ "	SP 8188-14 SUB	SP 8189-14 SUB
115 mm - 4 ¹ / ₂ "	SP 9188-11 TC	SP 9189-11 TC
145 mm - 5 ³ / ₄ "	SP9188-14 TC	SP 9189-14 TC
115 mm - 4 ¹ / ₂ "	SP 9188-11 SU TC	SP 9189-11 SU TC
145 mm - 5 ³ / ₄ "	SP 9188-14 SU TC	SP 9189-14 SU TC

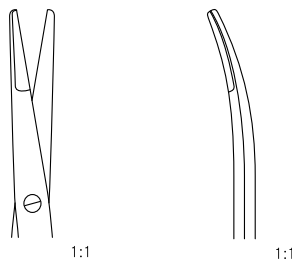
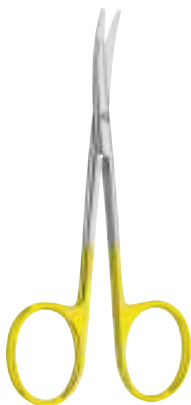

Greenberg Par

115 mm - 4 ¹ / ₂ "	SP 9198-11	SP 9199-11
115 mm - 4 ¹ / ₂ "	SP 9198-11 SU	SP 9199-11 SU
115 mm - 4 ¹ / ₂ "	SP 9198-11 SUB	SP 9199-11 SUB
115 mm - 4 ¹ / ₂ "	SP 9200-11 TC	SP 9201-11 TC
115 mm - 4 ¹ / ₂ "	SP 9200-11 SU TC	SP 9201-11 SU TC



if you have any question or are interested in any of the products in this catalog please email info@surgpro.com

Augenscheren | Ciseaux pour blépharoplastie
Blepharoplasty scissors | Tijeras para blefaroplastica
 Forbici per blefaroplastica



1:2



1:1



1:1

Kaye Blepharoplasty

115 mm - 4 1/2"	SP 8134-11	SP 8135-11
115 mm - 4 1/2"	SP 8134-11 SU	SP 8135-11 SU
115 mm - 4 1/2"	SP 8134-11 SUB	SP 8135-11 SUB
115 mm - 4 1/2"	SP 9134-11 TC	SP 9135-11 TC
115 mm - 4 1/2"	SP 9134-11 SU TC	SP 9135-11 SU TC



1:2



1:1



1:1

Kaye Ribbon Type

115 mm - 4 1/2"	SP 9179-11	SP 9180-11
-----------------	-------------------	-------------------



if you have any question or are interested in any of the products in this catalog please email info@surgpro.com

Mikro-Federscheren
Micro-scissors

Micro ciseaux à ressorts
Micro tijeras con resorte
Forbici per microchirurgia

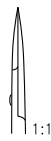

1:1

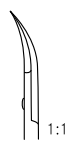

1:1

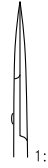

1:1

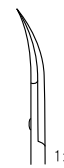

1:1

150 mm - 6"	SP 25670-15	SP 25671-15	SP 25672-15	SP 25673-15
	gerade, kurze Schneide <i>straight, short blades</i> droite, lames courtes <i>recta, hojas cortas</i> retta, lama corta	gebogen, kurze Schneide <i>curved, short blades</i> courbe, lames courtes <i>curva, hojas cortas</i> curva, lama corta	gerade, lange Schneide <i>straight, long blades</i> droite, lames longues <i>recta, hojas largas</i> retta, lama lunga	gebogen, lange Schneide <i>curved, long blades</i> courbe, lames longues <i>curva, hojas largas</i> curva, lama lunga



1:1



1:1

150 mm - 6"	SP 25678-15	SP 25679-15
	gerade, gezahnt <i>straight, saw edge</i> droite, dentelée <i>recta, dentadas</i> retta, dentata	gebogen, gezahnt <i>curved, saw edge</i> courbe, dentelée <i>curva, dentadas</i> curva, dentata

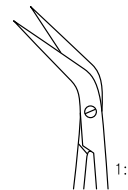

1:1

150 mm - 6"	SP 25675-15
180 mm - 7"	SP 25677-18

kniegebogen, 45°
angled on flat, 45°
angulaire, 45°
acodada, 45°
angolata, 45°



if you have any question or are interested in any of the products in this catalog please email info@surgpro.com

Mikro-Präparierscheren
Micro dissecting scissors

Micro ciseaux à dissection
Micro tijeras de disección

Forbici per micro chirurgia con manico rotondo

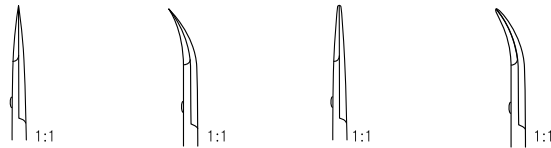

145 mm - 5 ³ / ₄ "	SP 25602-01	SP 25603-01	SP 25602-02	SP 25603-02
180 mm - 7 "	SP 25610-01	SP 25611-01	SP 25610-02	SP 25611-02

kurze Schneide 8 mm, glatt
short blades 8 mm, smooth
lames courtes 8 mm, lisses
hojas cortas 8 mm, lisos
lama corta 8 mm, liscia

gerade, spitz
straight, sharp
droites, pointues
rectas, agudas
retta, acuta

gebogen, spitz
curved, sharp
courbes, pointues
curvas, agudas
curva, acuta

gerade, stumpf
straight, blunt
droites, mousses
rectas, romas
retta, smussa

gebogen, stumpf
curved, blunt
courbes, mousses
curvas, romas
curva, smussa

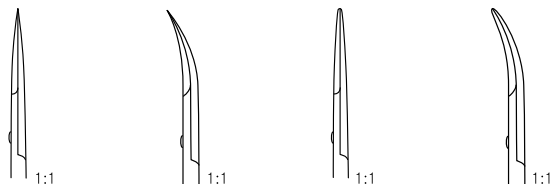

145 mm - 5 ³ / ₄ "	SP 25602-03	SP 25603-03	SP 25602-04	SP 25603-04
180 mm - 7 "	SP 25610-03	SP 25611-03	SP 25610-04	SP 25611-04

lange Schneide 14 mm, glatt
long blades 14 mm, smooth
lames longues 14 mm, lisses
hojas largas 14 mm, lisos
lama lunga 14 mm, liscia

gerade, spitz
straight, sharp
droites, pointues
rectas, agudas
retta, acuta

gebogen, spitz
curved, sharp
courbes, pointues
curvas, agudas
curva, acuta

gerade, stumpf
straight, blunt
droites, mousses
rectas, romas
retta, smussa

gebogen, stumpf
curved, blunt
courbes, mousses
curvas, romas
curva, smussa



if you have any question or are interested in any of the products in this catalog please email info@surgpro.com

Mikroscheren mit Rundgriff
Micro scissors with round handle

Micro ciseaux avec manche ronde
Micro tijeras con mango redondo
 Forbici per micro chirurgia con manico rotondo



Vannas



	7 mm Ø	7 mm Ø
120 mm - 5 "	SP 25612-12	SP 25613-12

Vannas

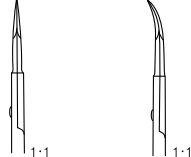

	8 mm Ø	8 mm Ø
150 mm - 6 "	SP 25600-15	SP 25601-15

Castroviejo

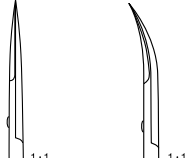

	8 mm Ø	8 mm Ø
150 mm - 6 "	SP 25610-15	SP 25611-15



if you have any question or are interested in any of the products in this catalog please email info@surgpro.com

Mikroscheren mit Rundgriff
Micro scissors with round handle

Micro ciseaux avec manche ronde
Micro tijeras con mango redondo
 Forbici per micro chirurgia con manico rotondo

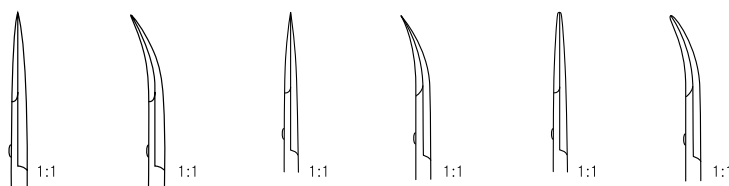

	180 mm - 7"	180 mm - 7"	180 mm - 7"	180 mm - 7"	180 mm - 7"	180 mm - 7"
8 mm Ø	SP 25606-18	SP 25607-18				
10 mm Ø	SP 25602-18	SP 25603-18	SP 25618-18	SP 25619-18	SP 25620-18	SP 25621-18



if you have any question or are interested in any of the products in this catalog please email info@surgpro.com

Anatomische Pinzetten - Chirurgische Pinzetten
Dressing forceps - Dissecting forceps

Pinces à dissection - Pincas à dissection à griffes
Pinzas de disección - Pinzas de disección con dientes
 Pinze per dissezione - Pinze per dissezione con denti



Semken

125 mm - 5"	SP 10300-12	SP 11300-12
150 mm - 6"	SP 10300-15	SP 11300-15

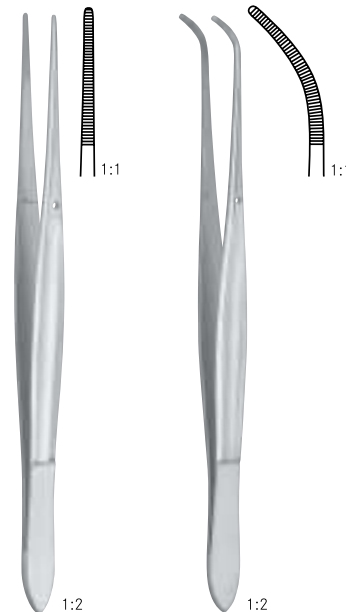

Cushing

175 mm - 7"	SP 10400-17	SP 10401-17
175 mm - 7"	SP 10402-17 TC	



if you have any question or are interested in any of the products in this catalog please email info@surgpro.com

Anatomische Pinzetten - Chirurgische Pinzetten
Dressing forceps - Dissecting forceps

Pinces à dissection - Pinces à dissection à griffes
Pinzas de disección - Pinzas de disección con dientes
 Pinze per dissezione - Pinze per dissezione con denti



Gillies
 150 mm - 6 "
SP 11250-15



Mc Indoe
 150 mm - 6 " **SP 10550-15**
 150 mm - 6 " **SP 11640-15 TC**



Wangensteen
 150 mm - 6 " **SP 10608-15**
 230 mm - 9 " **SP 10608-23**

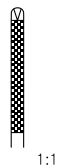

Oehler

	140 mm - 5 1/2 "	160 mm - 6 1/4 "	180 mm - 7 "
	SP 11690-14 TC	SP 11690-16 TC	SP 11690-18 TC

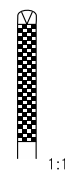
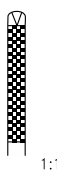

	200 mm - 8 "	250 mm - 9 3/4 "	300 mm - 12 "
	SP 11690-20 TC	SP 11690-25 TC	SP 11690-30 TC



if you have any question or are interested in any of the products in this catalog please email info@surgpro.com

Anatomische Pinzetten - Chirurgische Pinzetten
Dressing forceps - Dissecting forceps

Pincers à dissection - Pincers à dissection à griffes
Pinzas de disección - Pinzas de disección con dientes
 Pinze per dissezione - Pinze per dissezione con denti

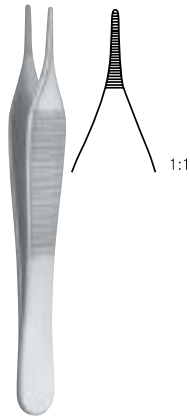

Adson

120 mm - 4 ³ / ₄ "	SP 10500-12
150 mm - 6"	SP 10500-15
120 mm - 4 ³ / ₄ "	SP 10502-12 TC
150 mm - 6"	SP 10502-15 TC

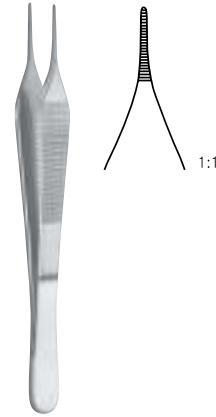

Micro-Adson

120 mm - 4 ³ / ₄ "	SP 10503-12
150 mm - 6"	SP 10503-15



Adson-Graefe

120 mm - 4 ³ / ₄ "	SP 11212-12
--	--------------------



Adson Brown

120 mm - 4 ³ / ₄ "	SP 11210-12
120 mm - 4 ³ / ₄ "	SP 10508-12 TC



if you have any question or are interested in any of the products in this catalog please email info@surgpro.com

Anatomische Pinzetten - Chirurgische Pinzetten
Dressing forceps - Dissecting forceps

Pinces à dissection - Pinces à dissection à griffes
Pinzas de disección - Pinzas de disección con dientes
 Pinze per dissezione - Pinze per dissezione con denti

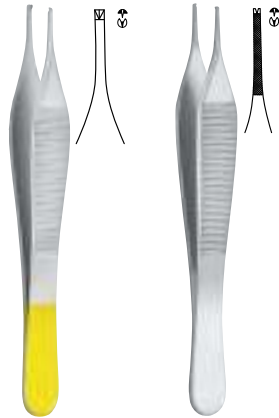

Adson

120 mm - 4 ³ / ₄ "	SP 11200-12	SP 11204-12
150 mm - 6"	SP 11200-15	
120 mm - 4 ³ / ₄ "	SP 10504-12 TC	
150 mm - 6"	SP 10504-15 TC	

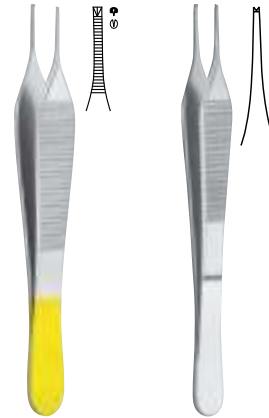

Micro-Adson

SP 11202-12	SP 11206-12
SP 11202-15	SP 11206-15
SP 10506-12 TC	
SP 10506-15 TC	



1:2

Adson

120 mm - 4 ³ / ₄ "
SP 11206-13
mit Fadenplatte 1 mm
<i>with tying platform 1 mm</i>
avec plateforme pour sutures 1 mm
<i>con plataforma para suturas 1 mm</i>
con piattaforma per suture 1 mm



1:2

Ultra-Micro-Adson
 (Braka)

120 mm - 4 ³ / ₄ "
SP 11206-12B
mit Fadenplatte 1 mm
<i>with tying platform 1 mm</i>
avec plateforme pour sutures 1 mm
<i>con plataforma para suturas 1 mm</i>
con piattaforma per suture 1 mm



if you have any question or are interested in any of the products in this catalog please email info@surgpro.com

Anatomische Pinzetten - Chirurgische Pinzetten
Dressing forceps - Dissecting forceps

Pinces à dissection - Pinces à dissection à griffes
Pinzas de disección - Pinzas de disección con dientes
 Pinze per dissezione - Pinze per dissezione con denti

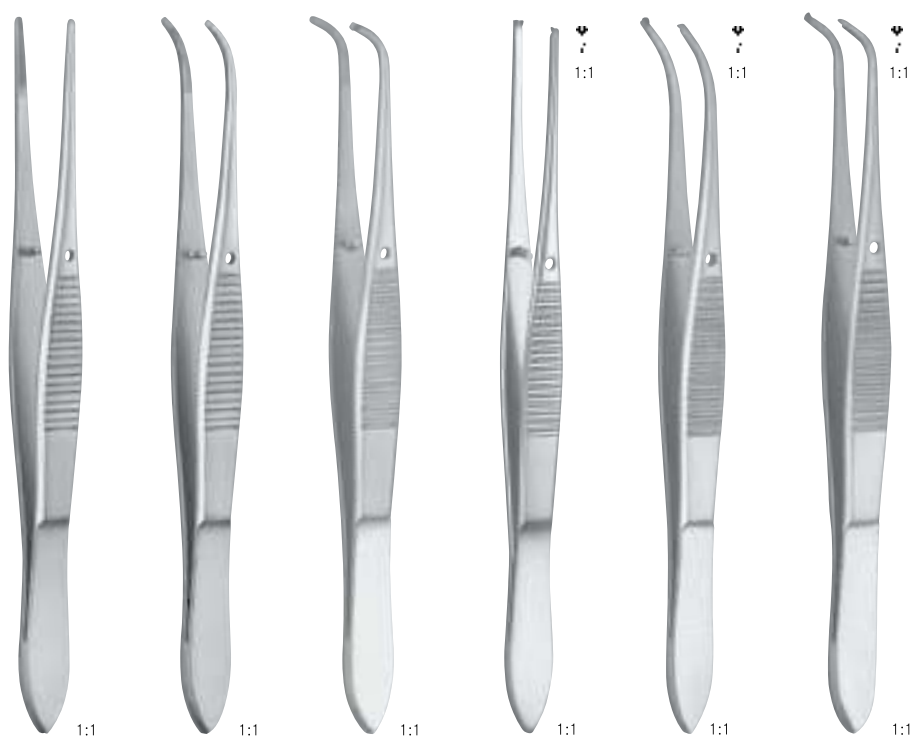

Graefe

105 mm - 4 1/4"

SP 11700-10

SP 11701-10

SP 11703-10

SP 11730-10

SP 11731-10

SP 11733-10



if you have any question or are interested in any of the products in this catalog please email info@surgpro.com

Anatomische Pinzetten - Chirurgische Pinzetten
Dressing forceps - Dissecting forceps

Pinces à dissection - Pinces à dissection à griffes
Pinzas de disección - Pinzas de disección con dientes
 Pinze per dissezione - Pinze per dissezione con denti

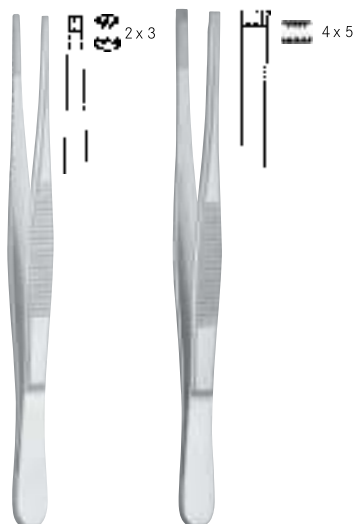

Adlerkreutz		
150 mm - 6 "	SP 11086-15	SP 11087-15 SP
200 mm - 8 "	SP 11086-20	11087-20 SP
250 mm - 9 ³ / ₄ "		11087-25



Waugh	
150 mm - 6 "	SP 10616-15 SP
200 mm - 8 "	10616-20 SP
250 mm - 9 ³ / ₄ "	10616-25



Duehrssen
 200 mm - 8 " **SP**
10604-20



105 mm - 4¹/₄ "
SP 11635-10
Columella Pinzette
Columella forceps
 Pince à columella
 Pinza para columella
 Pinze per columella



if you have any question or are interested in any of the products in this catalog please email info@surgpro.com

Anatomische Pinzetten - Chirurgische Pinzetten
Dressing forceps - Dissecting forceps

Pinces à dissection - Pinces à dissection à griffes
Pinzas de disección - Pinzas de disección con dientes
 Pinze per dissezione - Pinze per dissezione con denti



Potts-Smith

180 mm - 7"	SP 11150-18	SP 11151-18
210 mm - 8 $\frac{3}{4}$ "	SP 11150-21	SP 11151-21
250 mm - 9 $\frac{3}{4}$ "	SP 11150-25	SP 11151-25



Brophy

200 mm - 8"	SP 11100-20	SP 11101-20
-------------	-----------------------------	-----------------------------



if you have any question or are interested in any of the products in this catalog please email info@surgpro.com

Anatomische Pinzetten - Chirurgische Pinzetten
Dressing forceps - Dissecting forceps

Pinces à dissection - Pinces à dissection à griffes
Pinzas de disección - Pinzas de disección con dientes
 Pinze per dissezione - Pinze per dissezione con denti

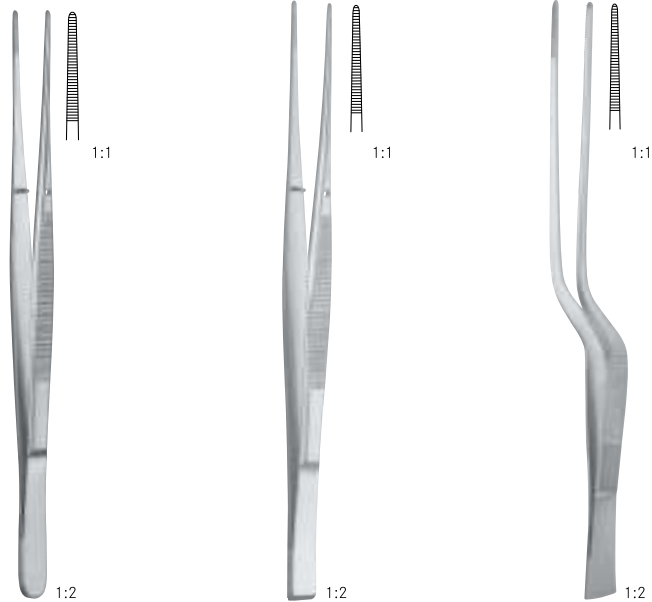

Taylor

175 mm - 7

SP 10310-17

SP 10312-17

SP 10313-17

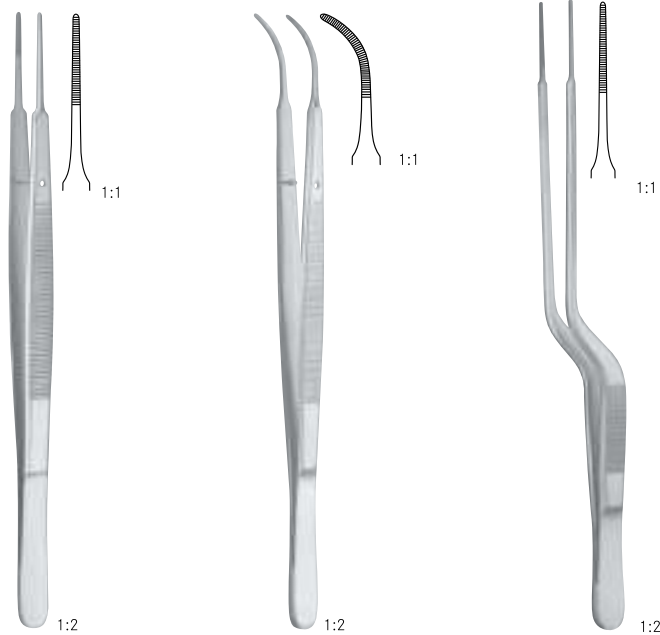

Gerald

180 mm - 7

SP 10324-18

SP 10325-18

SP 10326-19



if you have any question or are interested in any of the products in this catalog please email info@surgpro.com

Atraumatische Pinzetten
Atraumatic tissue forceps

Pinces atraumatiques
Pinzas de disección atraumáticas
Pinze per dissezione atraumatiche



De Bakey-Gerald	
150 mm – 6 "	SP 10327-15
180 mm – 7 "	SP 10327-18



De Bakey Bayonet	
180 mm – 7 "	SP 10328-18
200 mm – 8 "	SP 10328-20





if you have any question or are interested in any of the products in this catalog please email info@surgpro.com

Atraumatische Pinzetten
Atraumatic tissue forceps

Pinces atraumatiques
Pinzas de disección atraumáticas
 Pinze per dissezione atraumatiche

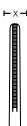

De Bakey		
	x = 1.5 mm	x = 2.0 mm
120 mm - 4 ³ / ₄ "	SP 11960-12	
145 mm - 5 ³ / ₄ "	SP 11960-14	SP 11964-14
160 mm - 6 ¹ / ₄ "	SP 11960-16	SP 11964-16
200 mm - 8"	SP 11960-20	SP 11964-20
240 mm - 9 ¹ / ₂ "	SP 11960-24	SP 11964-24
300 mm - 12"		SP 11964-30



if you have any question or are interested in any of the products in this catalog please email info@surgpro.com

Atraumatische Pinzetten
Atraumatic tissue forceps

Pinces atraumatiques
Pinzas de disección atraumáticas
 Pinze per dissezione atraumatiche

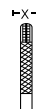

De Bakey

	x = 1.5 mm	x = 2.0 mm
150 mm - 6 "	SP 11968-15 TC	SP 11969-15 TC
190 mm - 7 1/2 "	SP 11968-19 TC	SP 11969-19 TC
240 mm - 9 1/2 "	SP 11968-24 TC	SP 11969-24 TC



if you have any question or are interested in any of the products in this catalog please email info@surgpro.com

Mikro-Pinzetten | Pinces micro
Micro forceps | *Micro pinzas*
 Micro pinze



	x = 0.3 mm	x = 0.5 mm
150 mm - 6 "	SP 25686-30	
180 mm - 7 "		SP 25686-35

mit Fadenplatte
with tying platform
 avec plateforme pour sutures
con plataforma para suturas
 con plattaforma per suture



	x = 0.3 mm	x = 0.5 mm
150 mm - 6 "	SP 25687-30	
180 mm - 7 "		SP 25687-335



mit Fadenplatte
with tying platform
 avec plateforme pour sutures
con plataforma para suturas
 con plattaforma per suture



if you have any question or are interested in any of the products in this catalog please email info@surgpro.com

Mikro-Pinzetten | Pinces micro
Micro forceps | *Micro pinzas*
 Micro pinze

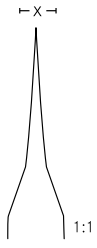
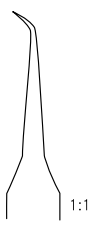
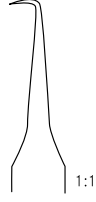

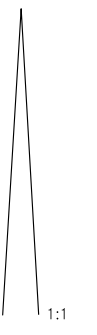
Typ					
Juwelie	1:1	1:1	1:1	1:1	1:1
	x = 0.2 mm	x = 0.3 mm	x = 0.3 mm	x = 0.2 mm	x = 0.3 mm
	110 mm - 4 ¹ / ₄ "	110 mm - 4 ¹ / ₄ "	110 mm - 4 ¹ / ₄ "	120 mm - 4 ³ / ₄ "	120 mm - 4 ³ / ₄ "
	SP 26001-11	SP 26002-11	SP 26003-11	SP 26005-12	SP 26006-13



if you have any question or are interested in any of the products in this catalog please email info@surgpro.com

Mikro-Pinzetten | Pinces micro
Micro forceps | *Micro pinzas*
Micro pinze



Pierse

120 mm - 4 ⁷ / ₄ "	SP 26009-12
"	
135 mm - 5"	SP 26009-13



if you have any question or are interested in any of the products in this catalog please email info@surgpro.com

Gefäßdilatoren
Vessel dilators

Dilatateurs vasculaires
Dilatadores vasculares
Dilatatori vascolari

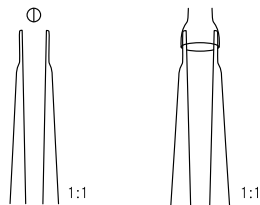

	x = 0.2 mm	x = 0.3 mm
110 mm - 4 1/4 "	SP 26015-02	SP 26015-03

sehr fein
very fine
très fin
muy fino
molto fino



	x = 0.3 mm
150 mm - 6 "	SP 26015-04
180 mm - 7 "	SP 26015-05

mit Fadenplatte
with tying platform
avec plateforme pour sutures
con plataforma para suturas
con piattaforma per suture



if you have any question or are interested in any of the products in this catalog please email info@surgpro.com

Approximatoren, Gefäßclips nach Biemer
Approximators, Biemer clips

Approximateurs, clips selon Biemer
Approximadores, Biemer clips
Approssimatori, clips vascolari Biemer



Bi e m e

	SP 25209-02	SP 25209-01
	Anlegepinzette mit Schloss <i>applying forceps with lock</i> pince à poser avec verrou <i>aplicadora con cierre</i> pinza posa clips con cremagliera	Anlegepinzette ohne Schloss <i>applying forceps without lock</i> pince à poser sans verrou <i>aplicadora sin cierre</i> pinza posa clips senza cremagliera



	x	y	gms
	Maullänge <i>jaw length</i> longueur du mors <i>longitud de la boca</i> lunghezza del morso	max. Maulöffnung <i>max. jaw opening</i> ouverture max. du mors <i>apertura max. de la boca</i> apertura mass.	Schließkraft <i>closing pressure</i> force de fermeture <i>fuerza de cierre</i> pressione



SP 25210-00

x = 6 mm
x = 4 mm
30 gms - 40 gms

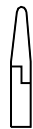

SP 25211-00

x = 9 mm
x = 5 mm
30 gms - 40 gms



SP 25212-00

x = 9 mm
x = 5 mm
20 gms - 25 gms

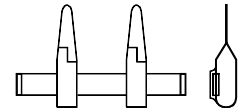

SP 25213-00

x = 4,5 mm
x = 3,0 mm
30 gms - 40 gms

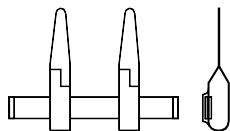

SP 25214-00

x = 9 mm
x = 5 mm
30 gms - 40 gms

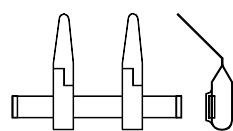

SP 25215-00

x = 9 mm
x = 5 mm
30 gms - 40 gms

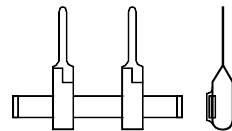

SP 25216-00

x = 9 mm
x = 5 mm
20 gms - 25 gms

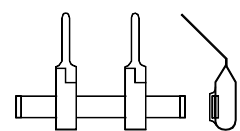

SP 25217-00

x = 9 mm
x = 5 mm
30 gms - 40 gms

Für temporären Gebrauch, (gekennzeichnet durch gelb eingefärbte Federenden) für Gefäße mit 0,5 mm - 2,0 mm Ø. Maulinnenflächen schräg gerieft für schonendes und sicheres Festhalten der Gefäße. Der fest eingestellte Schliessdruck gewährt risikofreie Anwendung

For temporary occlusion, (identified by yellow coloured spring ends) for vessels of 0,5 mm - 2,0 mm Ø. Blade gripping surface with oblique serrations for save but careful gripping of vessels. No risk due to rigidly fixed pressure measure

Pour usage temporaire, (ressorts couleur jaune) pour vaisseau de 0,5 mm - 2,0 mm Ø. Mors striés pour fixation sûre et manégement. Force de fermeture non changeable

Para oclusión temporal (ressortes amarillos) para vasos de 0,5 mm - 2,0 mm Ø. Boca estriada para fijación segura y moderada de los vasos. Utilización sin riesgo con fuerza de oclusión fija

Per uso temporaneo, con finale della molla giallo, per vasi di 0,5 mm - 2,0 mm Ø. Morso zignanto per una presa sicura, non traumatica



if you have any question or are interested in any of the products in this catalog please email info@surgpro.com

Anlegepinzetten für Gefäßclips
Applying forceps for vessel clips

Pinces à poser des clips
Aplicadoras para clips
 Pinze per mettere clips



140 mm - 5 1/2 "	SP 25059-01	SP 25059-02
	ohne Schloß <i>without lock</i>	mit Schloß <i>with lock</i>
	sans serrure <i>sin cierre</i>	avec serrure <i>con cierre</i>
	senza cremagliera	con cremagliera



140 mm - 5 1/2 "	SP 25059-03
	für Approximatoren und Doppelklemmen <i>for approximators and double-clips</i>
	pour approximateurs et clips doubles <i>para aproximadores y clips dobles</i>
	per approssimatori e clips doppi



x	Ø	V	A
Länge	Gefäß	Vene	Arterie
Length	Vessel	Vein	Artery
Longueur	Vaisseau	Veine	Artère
Longitud	Vaso	Vena	Arteria
Lunghezza	Vaso	Vena	Arteria



Weitere Modelle und Ausführungen auf Anfrage
Other models and executions upon request
 Autres modèles et exécutions sur demande
 Otros modelos y ejecuciones segun demanda
 Altri modelli a richiesta

















50 x 25 x 4.5 mm	75 x 25 x 4.5 mm	70 x 45 x 8 mm
SP 55210-01	SP 55210-02	SP 55210-03

Lagerungstrays für Gefäßclips
Trays for storage of vessel clips
 Boîtes pour clips vasculaires
Caixas para clips vasculares
 Trays per clips vascolari

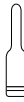
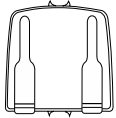
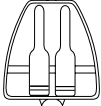
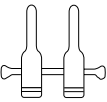

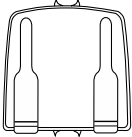
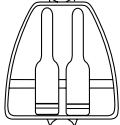
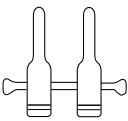
if you have any question or are interested in any of the products in this catalog please email info@surgpro.com

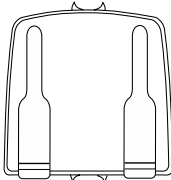
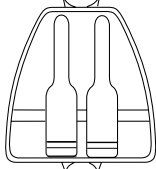
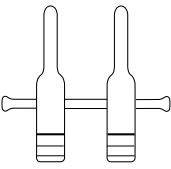
Approximateurs, clips | Approximateurs, clips
Approximators, clips | *Approximadores, clips*
 Approssimatori, clips vascolari

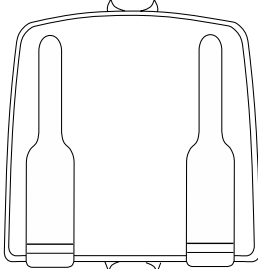
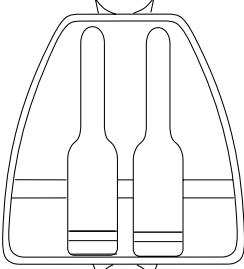
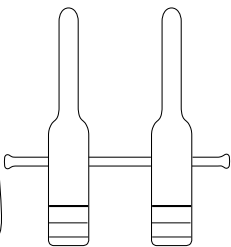
x = 8 mm V				
				
	SP 25060-01	SP 25060-02	SP 25060-03	SP 25060-04
A	SP 25070-01	SP 25070-02	SP 25070-03	SP 25070-04
Ø = 0,4 mm - 1 mm				
x = 11 mm V				
				
	SP 25061-01	SP 25061-02	SP 25061-03	SP 25061-04
A	SP 25071-01	SP 25071-02	SP 25071-03	SP 25071-04
Ø = 0,6 mm - 1,5 mm				
x = 14 mm V				
				
	SP 25062-01	SP 25062-02	SP 25062-03	SP 25062-04
A	SP 25072-01	SP 25072-02	SP 25072-03	SP 25072-04
Ø = 1 mm - 2 mm				
x = 17 mm V				
				
	SP 25063-01	SP 25063-02	SP 25063-03	SP 25063-04
A	SP 25073-01	SP 25073-02	SP 25073-03	SP 25073-04
Ø = 1 mm - 2,25 mm				
x = 25 mm V				
				
	SP 25064-01	SP 25064-02	SP 25064-03	SP 25064-04
A	SP 25074-01	SP 25074-02	SP 25074-03	SP 25074-04
Ø = 1,5 mm - 3,5 mm				
x = 36 mm V				
				
	SP 25065-01	SP 25065-02	SP 25065-03	SP 25065-04
A	SP 25075-01	SP 25075-02	SP 25075-03	SP 25075-04



1,5 mm - 3,5 mm

if you have any question or are interested in any of the products in this catalog please email info@surgpro.com

Gewebe- und Darmfazzangen
Tissue and intestinal holding forceps

Pinces intestinales et de tissue
Pinzas para intestinos y tejidos
 Pinze per tessuti ed intestino



Babcock

160 mm - 6 1/4"	SP 28280-16-P
180 mm - 7"	SP 28280-18-P
200 mm - 8"	SP 28280-20-P



Allis

150 mm - 6"	SP 28140-15-P	SP 28160-15-P
190 mm - 7 1/2"		SP 28160-19-P

"	4x5	5x6
Zähne		
Teeth		
Dents		
Dientes		
Denti		



if you have any question or are interested in any of the products in this catalog please email info@surgpro.com



Arterienklemmen
Haemostatic forceps

Pinces hémostatiques
Pinzas hemostáticas
Pinze emostatiche

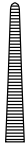
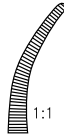



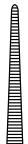

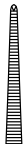
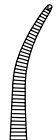
Hartmann 100 mm - 4"	 1:1	 1:1
	SP 12000-10-P	SP 12001-10-P



Micro- Mosquito 100 mm - 4" 1/2 mm - 4 3/4"	 1:1	 1:1	 1:1	 1:1
	SP 12020-10-P	SP 12021-10-P	SP 12022-10-P	SP 12023-10-P
	SP 12020-12-P	SP 12021-12-P	SP 12022-12-P	SP 12023-12-P
			1x2	1x2



Halsted- Mosquito 125 mm - 5" 140 mm - 5 1/2"	 1:1	 1:1	 1:1	 1:1
	SP 12010-12-P	SP 12011-12-P	SP 12012-12-P	SP 12013-12-P
	SP 12010-14-P	SP 12011-14-P	SP 12012-14-P	SP 12013-14-P
			1x2	1x2



if you have any question or are interested in any of the products in this catalog please email info@surgpro.com

Arterienklemmen | Pinces hémostatiques
 Haemostatic forceps | Pinzas hemostáticas
 Pinze emostatiche

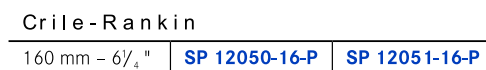
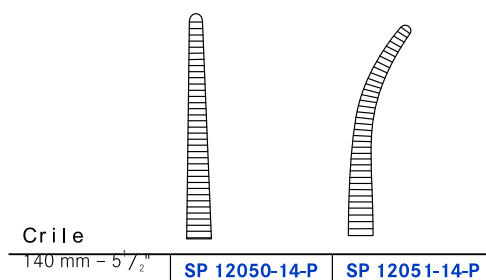
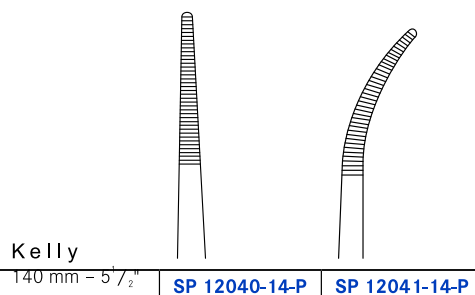

if you have any question or are interested in any of the products in this catalog please email info@surgpro.com

Arterienklemmen
Haemostatic forceps

Pinces hémostatiques
Pinzas hemostáticas
Pinze emostatiche

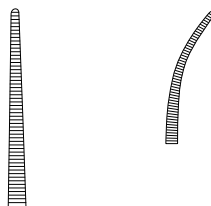

Pé a n

130 mm - 5"	SP 12058-13-	SP 12059-13-
140 mm - 5 1/2"	P SP 12058-	P SP 12059-
160 mm - 6 1/4"	14-P SP	14-P SP

graziles Modell
delicate pattern
modèle délicat
modelo delicado
modello delicato

12058-16-P **12059-16-P**

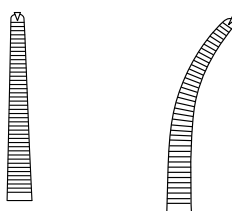

Kocher

130 mm - 5" 140	SP 12078-13-	SP 12079-13-
mm - 5 1/2" 160	P SP 12078-	P SP 12079-
mm - 6 1/4"	14-P SP	14-P SP

graziles Modell
delicate pattern
modèle délicat
modelo delicado
modello delicato

12078-16-P **12079-16-P**



if you have any question or are interested in any of the products in this catalog please email info@surgpro.com

Arterienklemmen | Pincas hémostatiques
Haemostatic forceps | *Pincas hemostáticas*
 Pinze emostatiche



Péan-Pino

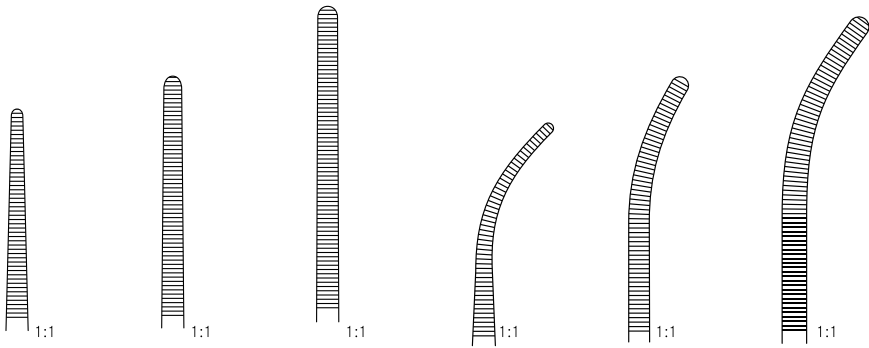

145 mm - 5 ³ / ₄ "	165 mm - 6 ¹ / ₂ "	185 mm - 7 ¹ / ₄ "	140 mm - 5 ¹ / ₂ "	160 mm - 6 ¹ / ₄ "	180 mm - 7 "
SP 12062-14-P	SP 12062-16-P	SP 12062-18-P	SP 12063-14-P	SP 12063-16-P	SP 12063-18-P



Kocher-Kino

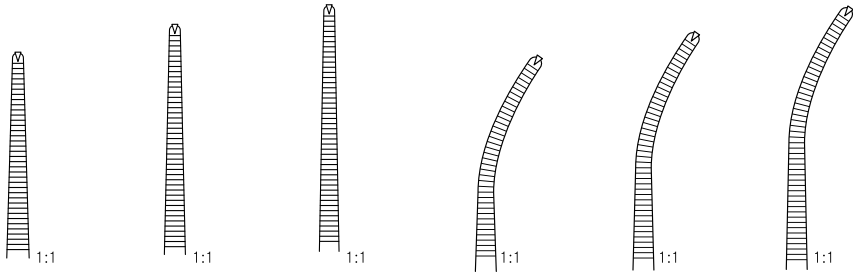

145 mm - 5 ³ / ₄ "	165 mm - 6 ¹ / ₂ "	185 mm - 7 ¹ / ₄ "	145 mm - 5 ³ / ₄ "	160 mm - 6 ¹ / ₄ "	180 mm - 7 "
SP 12082-14-P	SP 12082-16-P	SP 12082-18-P	SP 12083-14-P	SP 12083-16-P	SP 12083-18-P
1x2	1x2	1x2	1x2	1x2	1x2



if you have any question or are interested in any of the products in this catalog please email info@surgpro.com

Arterienklemmen
Haemostatic forceps

Pinces hémostatiques
Pinzas hemostáticas
Pinze emostatiche



1:2

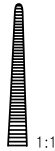

1:1



1:1

Hartmann

100 mm - 4"	SP 12000-10	SP 12001-10
-------------	--------------------	--------------------



Halsted-Hosquito



125 mm - 5"	SP 12010-12	SP 12011-12	SP 12012-12	SP 12013-12
140 mm - 5 ¹ / ₂ "	SP 12010-14	SP 12011-14	SP 12012-14	SP 12013-14

1x2

1x2

125 mm - 5"	SP 12110-12	SP 12111-12	SP 12112-12	SP 12113-12
-------------	--------------------	--------------------	--------------------	--------------------

Titan
Titanium
Titane
Titanio
Titanio

1x2

1x2



Micro-Mosquito

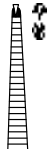

100 mm - 4"	SP 12020-10	SP 12021-10	SP 12022-10	SP 12023-10
120 mm - 4 ³ / ₄ "	SP 12020-12	SP 12021-12	SP 12022-12	SP 12023-12



if you have any question or are interested in any of the products in this catalog please email info@surgpro.com

Arterienklemmen | Pincas hémostatiques
Haemostatic forceps | *Pinzas hemostáticas*
 Pinze emostatiche



1:2

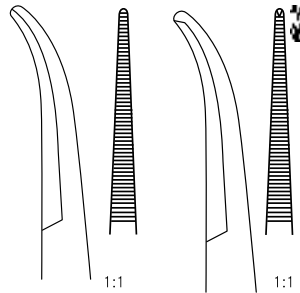

1:1

1:1

Dandy

140 mm - 5 1/2"

SP 12030-14

SP 12032-14

seitlich gebogen
curved to the side
 courbe sur le plat
curva al lado
 curvata lateralmente



1:2

Mosquito-Dandy

SP 12031-12 120 mm - 4 3/4"

seitlich gebogen
curved to the side
 courbe sur le plat
curva al lado
 curvata lateralmente



1:2

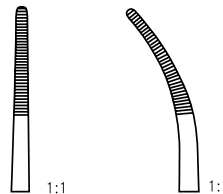

1:1

1:1

Providence-Hospital

140 mm - 5 1/2"

SP 12020-14

SP 12021-14



if you have any question or are interested in any of the products in this catalog please email info@surgpro.com

Arterienklemmen
Haemostatic forceps

Pinces hémostatiques
Pinzas hemostáticas
Pinze emostatiche

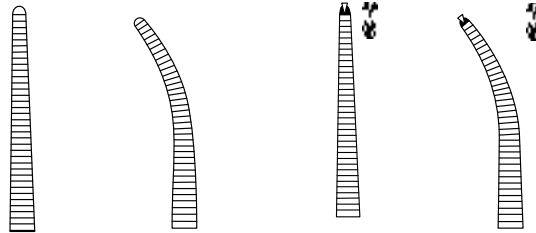

Crile

140 mm - 5 1/2"	SP 12050-14	SP 12051-14	SP 12052-14	SP 12053-14
-----------------	-----------------------------	-----------------------------	-----------------------------	-----------------------------

Crile-Rankin

160 mm - 6 1/4"	SP 12050-16	SP 12051-16	SP 12054-16	SP 12055-16
-----------------	-----------------------------	-----------------------------	-----------------------------	-----------------------------

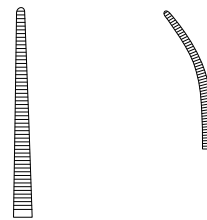

Péan

130 mm - 5" 1/4	SP 12058-13	SP 12059-13
mm - 5 1/2" 160	SP 12058-14	SP 12059-14
mm - 6 1/4"	SP 12058-16	SP 12059-16

graziles Modell
delicate pattern
modèle délicat
modelo delicado
modello delicato



if you have any question or are interested in any of the products in this catalog please email info@surgpro.com

Arterienklemmen <i>Haemostatic forceps</i>	Pincas hémostatiques <i>Pinzas hemostáticas</i> Pinze emostatiche
---	---



1:2



1:1



1:1

Leriche

150 mm - 6"

SP 12034-15

SP 12035-15



Kelly

140 mm - 5 1/2"

SP 12040-14

SP 12041-14

Kelly-Rankin

160 mm - 6 1/4"

SP 12040-16

SP 12041-16



if you have any question or are interested in any of the products in this catalog please email info@surgpro.com

Arterienklemmen
Haemostatic forceps

Pinces hémostatiques
Pinzas hemostáticas
Pinze emostatiche

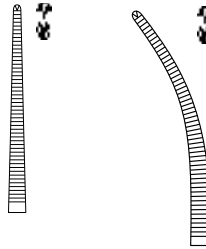

Kocher

130 mm - 5" 1/4	SP 12078-	SP 12079-
mm - 5" 1/2	13 SP	13 SP
mm - 6" 1/4	12078-14	12079-14

graziles Modell **SP 12078-** **SP 12079-**
delicate pattern **16** **16**
modèle délicat
modelo delicado
modello delicato

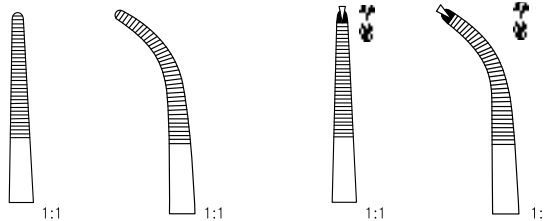

Adson

185 mm - 7 3/8"	SP 12210-18	SP 12211-18	SP 12212-18	SP 12213-18
-----------------	--------------------	--------------------	--------------------	--------------------



if you have any question or are interested in any of the products in this catalog please email info@surgpro.com

Arterienklemmen | Pincas hémostatiques
 Haemostatic forceps | Pincas hemostáticas
 Pinze emostatiche

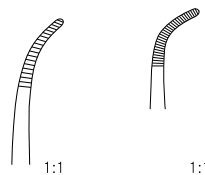

Baby - Mixter

140 mm - 5 1/2"	SP 12220-14	
180 mm - 7"		SP 12220-18

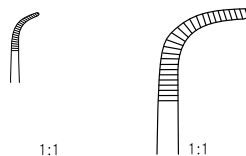

Baby - Adson

140 mm - 5 1/2"	SP 12221-14	
180 mm - 7"		SP 12221-18



if you have any question or are interested in any of the products in this catalog please email info@surgpro.com

Gewebe- und Darmfazzangen
Tissue and intestinal holding forceps

Pinces intestinales et de tissue
Pinzas para tejidos y intestinos
Pinze per tessuti ed intestinali



A llis-Baby

130 mm - 5" **SP 28100-14**
4 x 5



Allis

150 mm - 6" 190	SP 28140-15	SP 28160-15
mm - 7 ¹ / ₂ " 250		SP 28160-19
mm - 9 ³ / ₄ "		SP 28160-25
4 x 5		5 x 6



A llis-Adair

155 mm - 6"
SP 28167-15
10 x 11



Thoms-Allis

200 mm - 8" **SP 28180-20** 6 x 7



Lockwood

200 mm - 8"
SP 28190-20

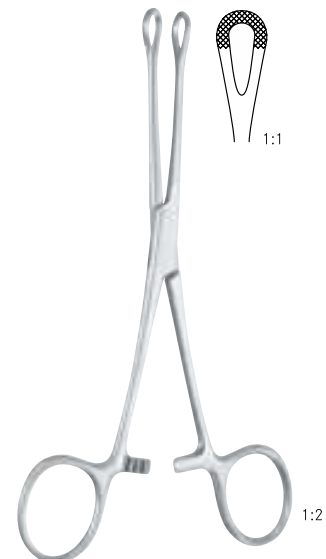

Williams

160 mm - 6¹/₄"
SP 28192-16



if you have any question or are interested in any of the products in this catalog please email info@surgpro.com

Tupfer- und Schwammzangen | Pincas à tampons et éponges
Cotton swab forceps, sponge holding forceps | Pinzas para tampones y esponjas
 Pinze per tamponi

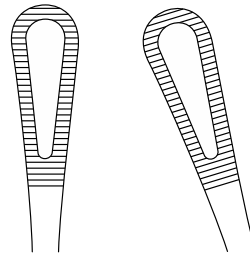

Rampl ey

180 mm - 7"	SP 15130-18	SP 15131-18
250 mm - 10"	SP 15130-25	SP 15131-25



Foerster (Ballenger)

180 mm - 7"	SP 15180-18	SP 15182-18 SP	SP 15183-18	SP 15185-18 SP
200 mm - 8"		18 SP	18	18 SP
250 mm - 10"	SP 15180-25	15182-20		15185-20
		SP 15182-25	SP 15183-25	SP 15185-25



if you have any question or are interested in any of the products in this catalog please email info@surgpro.com

Nasen- und Trachealhäkchen
Trachea and nose retractors

Ecarteurs nasales et trachéales
Separadores para la traquea y la nariz
 Uncini tracheali e nasali



1:2
Kilner
 150 mm – 6 "
SP 48128-15



1:2 1:1 1:1
Gillies

	Fig. 1	Fig. 2
180 mm – 7 "	SP 48130-01	SP 48130-02



1:2
Lange
 220 mm – 8 ⁷/₄ "
SP 16901-22



1:2
Cottle
 160 mm – 6 ¹/₄ "
SP 16902-16



1:2
Fomon
 170 mm – 6 ³/₄ "
SP 16904-17



if you have any question or are interested in any of the products in this catalog please email info@surgpro.com

Nasen- und Trachealhäkchen
Trachea and nose retractors

Ecarteurs nasales et trachéales
Separadores para la traquea y la nariz
Uncini tracheali e nasali

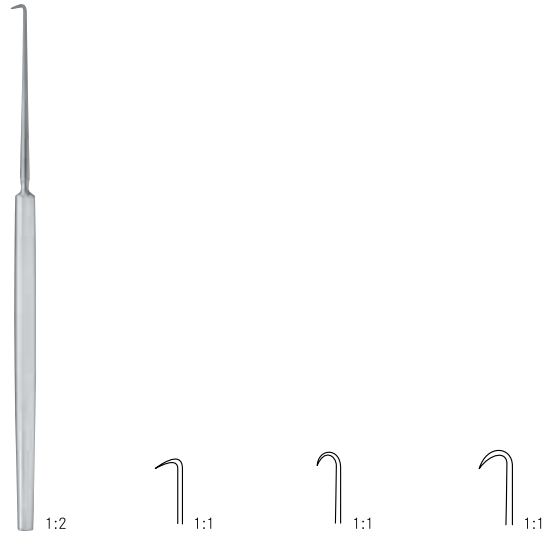

Cottle

150 mm - 6"	SP 16905-01	SP 16905-02	SP 16905-03
-------------	--------------------	--------------------	--------------------



Joseph

150 mm - 6"	SP 16900-15
-------------	--------------------

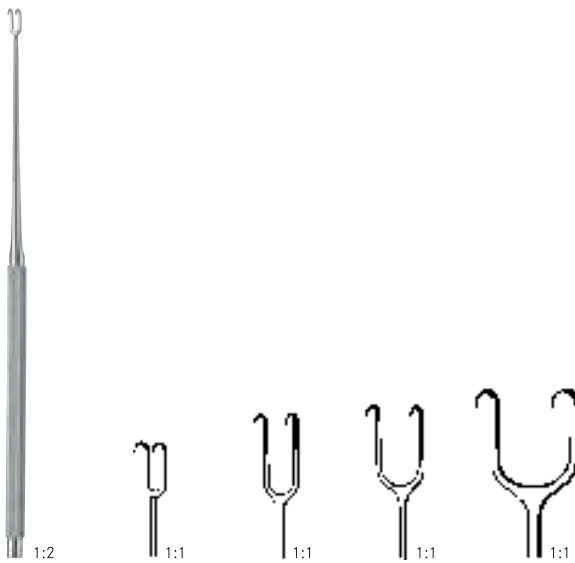

Joseph

	2 mm	5 mm	7 mm	10 mm
160 mm - 6 1/4"	SP 16910-02	SP 16910-05	SP 16910-07	SP 16910-10

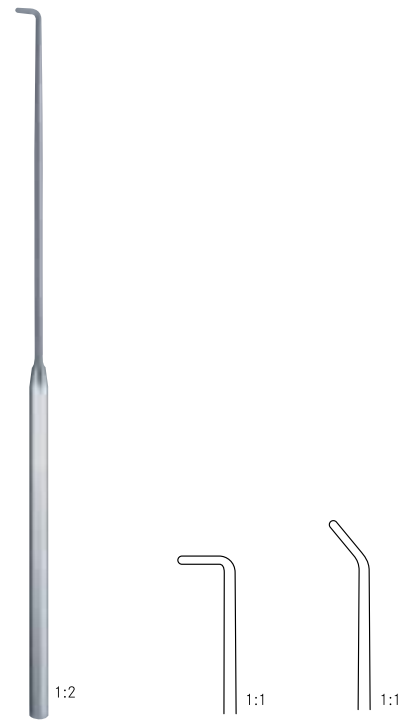

Crile

	Fig. 1	Fig. 2
200 mm - 8"	SP 25308-01	SP 25308-02



if you have any question or are interested in any of the products in this catalog please email info@surgpro.com

Nasen- und Trachealhäkchen
Trachea and nose retractors

Ecarteurs nasales et trachéales
Separadores para la traquea y la nariz
Uncini tracheali e nasali

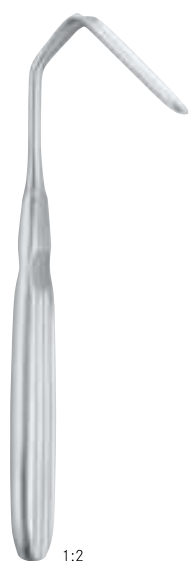

1:2
Aufricht
190 mm - 7 1/2"
" **SP 16906-19**



1:2
Aufricht
190 mm - 7 1/2"
" **SP 16906-59**



1:2
Aufricht
SP 17919-13
Nasenhaken
Nasal hook
Crochet pour le nez
Gancho para la nariz
Uncino nasale



1:2
Converse
120 mm - 4 3/4"
" **SP 16908-12**



if you have any question or are interested in any of the products in this catalog please email info@surgpro.com

Nasen- und Trachealhäkchen
Trachea and nose retractors

Ecarteurs nasales et trachéales
Separadores para la traquea y la nariz
Uncini tracheali e nasali



1:2

Kilner

100 mm - 4 "

SP 16907-10



1:2

Martinez Kilner

110 mm - 4¼ "

SP 16907-12



1:2

Cottle

SP 17750-00

Daumenhaken

Thumb hook

Crochet pour le doigt

Gancho para el dedo

Uncino da fissare sul

pollice



if you have any question or are interested in any of the products in this catalog please email info@surgpro.com

Nasen- und Trachealhäkchen
Trachea and nose retractors

Ecarteurs nasales et trachéales
Separadores para la traquea y la nariz
Uncini tracheali e nasali



Cottle-
Ceivert

200 mm - 8"

SP 16912-20



1:2

Fomon

160 mm - 6 3/4"

SP 16914-16



1:2

Cottle

150 mm - 6"



1:1

SP 16915-01



1:1

SP 16915-02

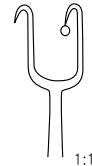

1:1

SP 16915-03



1:2

Neivert

160 mm - 6 3/4"

SP 16916-16



1:2

Cottle

150 mm - 6"

SP 16917-15

SP 16918-15



1:2



1:2

Iterson

160 mm - 6 3/4"

SP 16920-16



1:1

SP 16920-16

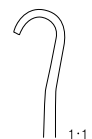

1:1

SP 16922-16



if you have any question or are interested in any of the products in this catalog please email info@surgpro.com

Trachealhäkchen | Ecarteurs nasales et trachéales
Trachea retractors | *Separadores para la traquea*
 Uncini tracheali

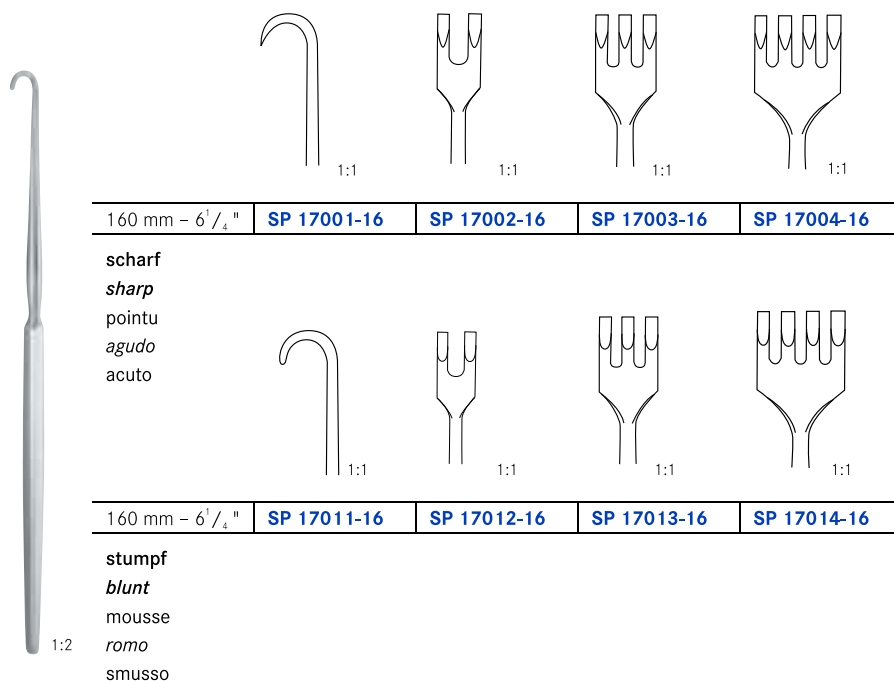

if you have any question or are interested in any of the products in this catalog please email info@surgpro.com

Trachealhäkchen
Trachea retractors

Ecarteurs trachéales
Separadores para la traquea
Uncini tracheali

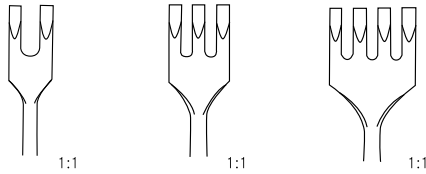

160 mm - 6 1/4"	SP 17021-16	SP 17022-16	SP 17024-16
-----------------	--------------------	--------------------	--------------------

fl exibel,
scharf fl
exible, sharp
fl exible, pointu
fl exible, agudo
fl essibile,
acuto

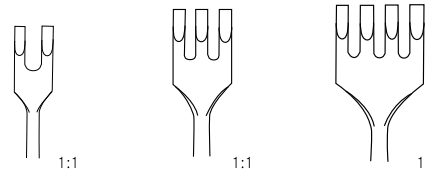

160 mm - 6 1/4"	SP 17031-16	SP 17032-16	SP 17034-16
-----------------	--------------------	--------------------	--------------------

fl exibel, stumpf
fl exible, blunt
fl exible, mousse
fl exible, romo
fl essibile,
smusso

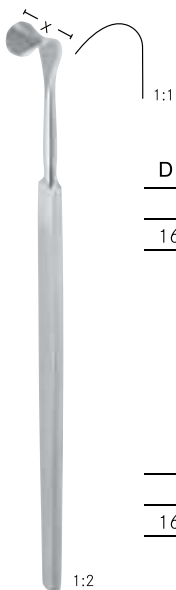

Desmarres

	x = 8 mm	x = 10 mm	x = 12 mm
160 mm - 6 1/4"	SP 17038-08	SP 17038-10	SP 17038-12

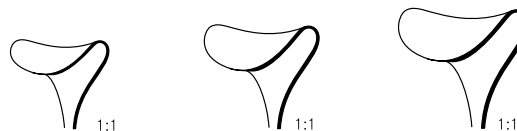

	x = 14 mm	x = 16 mm	x = 18 mm
160 mm - 6 1/4"	SP 17038-14	SP 17038-16	SP 17038-18



Knapp
(Rollet)
160 mm - 6 1/4"
" SP 17025-16

fl exibel,
scharf fl
exible, sharp
fl exible, pointu
fl exible, agudo
fl essibile,
acuto



if you have any question or are interested in any of the products in this catalog please email info@surgpro.com

Brust Dissektoren | Ecarteurs mammaires
Mamoplasty retractors | Separadores mamarias
 Divaricatori per seno

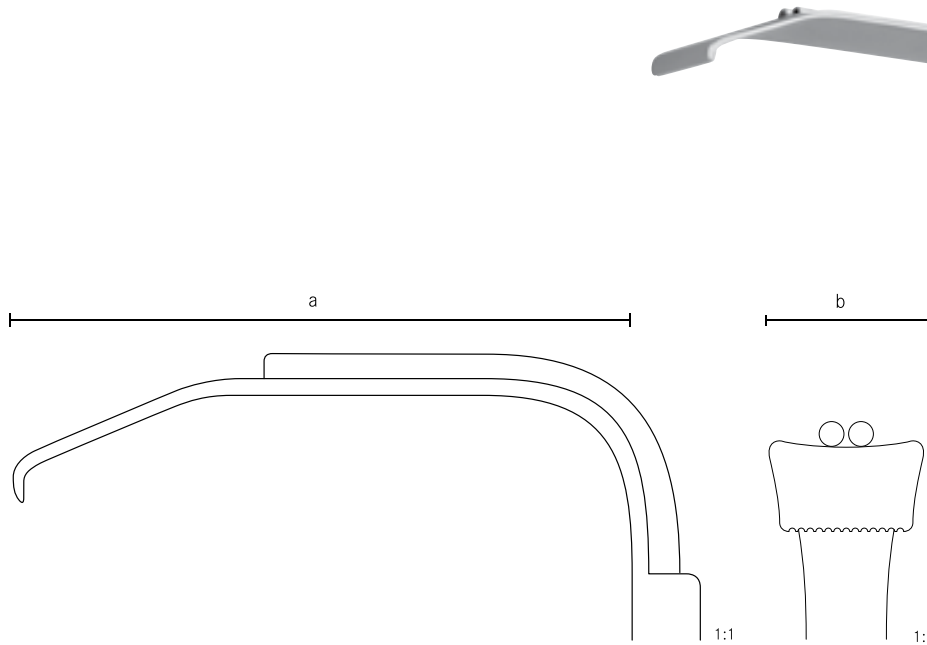

a	b	185 mm - 7/4"	185 mm - 7/4"
90 mm	24 mm	SP 17217-01 SP	SP 17217-06 SP
115	24 mm	17217-02 SP	17217-07 SP
mm	25 mm	17217-05 SP	17217-08 SP
150	36 mm	17217-03 SP	17217-09 SP
mm	30 mm	17217-04	17217-10

150
gezähnt und Kaltlichtbeleuchtung
toothed with fiber optic illumination
 dentelée avec illumination à lumière froide
190
 dentada con iluminación de luz fría
 dentata con illuminazione a luce fredda

mit Spülrohr
with irrigation tube
 avec tube de lavage
 con tubo lavador
 con tubo di lavaggio

ohne Spülrohr
without irrigation tube
 sans tube de lavage
 sin tubo lavador
 senza tubo di lavaggio

a	b	185 mm - 7/4"	185 mm - 7/4"
90 mm	24 mm	SP 17217-21 SP	SP 17217-26 SP
115	24 mm	17217-22 SP	17217-27 SP
mm	25 mm	17217-25 SP	17217-28 SP
150	36 mm	17217-23 SP	17217-29 SP
mm	30 mm	17217-24	17217-30

150
ohne Zähne mit Kaltlichtbeleuchtung non-
toothed with fiber optic illumination
 sans denture avec illumination à lumière froide
190
 dentada con iluminación de luz fría
 no dentata con illuminazione a luce fredda
 mit Spülrohr

with irrigation tube
 avec tube de lavage
 con tubo lavador
 con tubo di lavaggio
ohne Spülrohr
without irrigation

tube sans tube de
lavage
 sin tubo lavador
 senza tubo di lavaggio



if you have any question or are interested in any of the products in this catalog please email info@surgpro.com

Brust Dissektoren
Mamaplasty retractors

Ecarteurs mammaires
Separadores mamarias
Divaricatori per seno



1:2

MacCollum -
Mingman

315 mm - 12½"

SP 16903-30

Ferreira

a	b	185 mm - 7¼"	
90 mm	24 mm	SP 17219-01 SP	SP 17219-06 SP
115	24 mm	17219-02 SP	17219-07 SP
mm	25 mm	17219-03 SP	17219-08 SP
150	36 mm	17219-04 SP	17219-09 SP
mm	30 mm	17219-05	17219-10

150
Wundhaken
non
Retractors
190
Ecarteurs
Retractors
Divaricatori

ohne Zahnung
non - toothed
sans denture
sin dentada
no dentata

Gezahnt
toothed
denture
dentada
dentata



if you have any question or are interested in any of the products in this catalog please email info@surgpro.com

Brust Dissektoren | Ecarteurs mammaires
Mamplasty retractors | Separadores mamarias
 Divaricatori per seno



330 mm – 13 "	SP 17156-08 SP	SP 17156-10 SP	SP 17156-12
420 mm – 16½	17156-09 starr	17156-11 biegsam	SP 17156-13
" abgewinkelt	<i>rigid</i>	<i>malleable</i> maléable	Schaft isoliert
<i>angled</i>	<i>rigide</i>	<i>maleable</i> flessibile	<i>Shaft insulated</i>
<i>angulé</i>	<i>rigido</i>		Tige isolée
<i>angulado</i>	<i>rigido</i>		<i>Tija aislada</i>
<i>angolato</i>			Asta isolata



330 mm – 13 "	SP 17156-01 SP	SP 17156-03 SP	SP 17156-05
420 mm – 16½	17156-02 starr	17156-04 biegsam	SP 17156-06 Schaft
"	<i>rigid</i>	<i>malleable</i> maléable	isoliert <i>Shaft insulated</i>
	<i>rigide</i>	<i>maleable</i> flessibile	Tige isolée
	<i>rigido</i>		<i>Tija aislada</i>
	<i>rigido</i>		Asta isolata



	x = 25 mm	x = 33 mm
315 mm – 12½	SP 17156-20	SP 17156-21
" halbstarr		
<i>semi rigid</i>		
<i>semi rigide</i>		
<i>semi rigido</i>		
<i>semi rigido</i>		





if you have any question or are interested in any of the products in this catalog please email info@surgpro.com

Wundhaken
Retractors

Ecarteurs
Separadores
Divaricatori



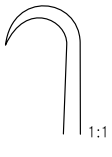
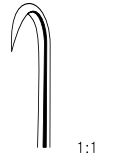
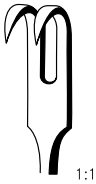
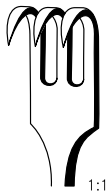
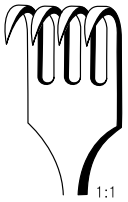
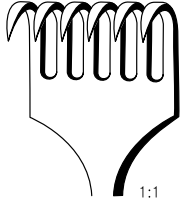

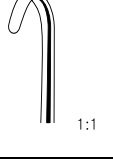
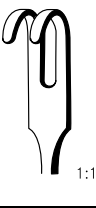
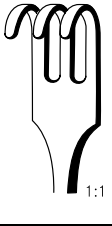
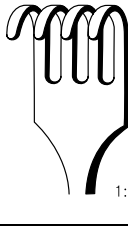
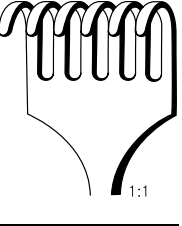
1:2

					
Volkmann					
215 mm - 8 1/2"					
SP 17061-21		SP 17062-21		SP 17063-21	
SP 17064-21		SP 17065-21		SP 17066-21	
scharf sharp pointu agudo acuto					
					
215 mm - 8 1/2"					
SP 17071-21		SP 17072-21		SP 17073-21	
SP 17074-21		SP 17075-21		SP 17076-21	
stumpf blunt mousse romo smusso					

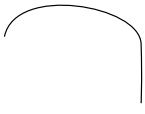
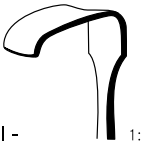
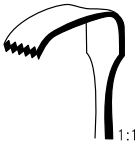

1:2

		
Strandell-Stille		
Fig. 1	Fig. 2	
190 mm - 7 1/2"	SP 17079-01	SP 17079-02
gezahnt saw edge dentelé dentado dentato		

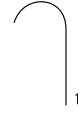
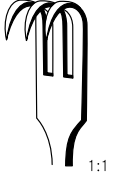
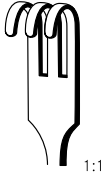

1:2

		
Senn-Muelle		
160 mm - 6 1/4"		
SP 17080-16		SP 17081-16
scharf sharp pointu agudo acuto	stumpf blunt mousse romo smusso	



1:2

if you have any question or are interested in any of the products in this catalog please email info@surgpro.com

Wundhaken - Wundspreizer
Retractors - Wound spreaders, self-retaining

Ecarteurs - Ecarteurs autostatiques
Separadores - Separadores autoestáticos
Divaricatori - Divaricatori autostatici



1:2



Meyerding

	18 mm x 7 mm	10 mm x 3 mm
180 mm - 7"	SP 17090-18	SP 17091-18



	16 mm x 5 mm	7 mm x 4 mm
180 mm - 7"	SP 17092-18	SP 17093-18

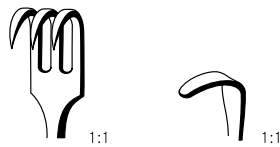

	10 mm x 4 mm	7 mm x 4 mm
180 mm - 7"	SP 17094-18	SP 17095-18



Ragnell Davis

140 mm - 5 1/2"	SP 17084-14
-----------------	--------------------

15 mm x 5,5 mm



1:2

Alm

	4 x 4	4 x 4	4 x 4
70 mm - 2 3/4"	SP 17330-07	SP 17330-17	SP 17331-07
100 mm - 4"	SP 17330-10	SP 17330-20	SP 17331-10

scharf	halbscharf	stumpf
<i>sharp</i>	<i>semi sharp</i>	<i>blunt</i>
pointu	semi pointu	mousse
<i>agudo</i>	<i>semi agudo</i>	<i>romo</i>
acuto	semi acuto	smusso



1:2

Holtzheimer

	4 x 4	4 x 4
100 mm - 4"	SP 17336-10	SP 17337-10

scharf	stumpf
<i>sharp</i>	<i>blunt</i>
pointu	mousse
<i>agudo</i>	<i>romo</i>
acuto	smusso



if you have any question or are interested in any of the products in this catalog please email info@surgpro.com

Wundhaken | Ecarteurs
 Retractors | Separadores
 Divaricatori



Freeman

	x = 22 mm
100 mm - 4"	SP 17147-09

scharf
 sharp
 pointu
 agudo
 acuto



Freeman

	x = 38 mm
100 mm - 4"	SP 17147-10

scharf
 sharp
 pointu
 agudo
 acuto



Gorney

	x = 38 mm
75 mm - 3"	SP 17148-38

scharf
 sharp
 pointu
 agudo
 acuto



if you have any question or are interested in any of the products in this catalog please email info@surgpro.com

Wundhaken | Ecarteurs
Retractors | *Separadores*
 Divaricatori



Freeman

	x = 22 mm	x = 38 mm
180 mm - 7"	SP 17147-22	SP 17147-38

scharf
sharp
 pointu
agudo
 acuto



if you have any question or are interested in any of the products in this catalog please email info@surgpro.com

Wundhaken
Retractors

Ecarteurs
Separadores
Divaricatori



1:2

Yancoskie

	x = 150 mm
180 mm - 7"	SP 17144-15

scharf
sharp
pointu
agudo
acuto



1:2

C oronal lift

	x = 70 mm
180 mm - 7"	SP 17145-18

scharf
sharp
pointu
agudo
acuto



if you have any question or are interested in any of the products in this catalog please email info@surgpro.com

Wundhaken | Ecarteurs
Retractors | *Separadores*
 Divaricatori

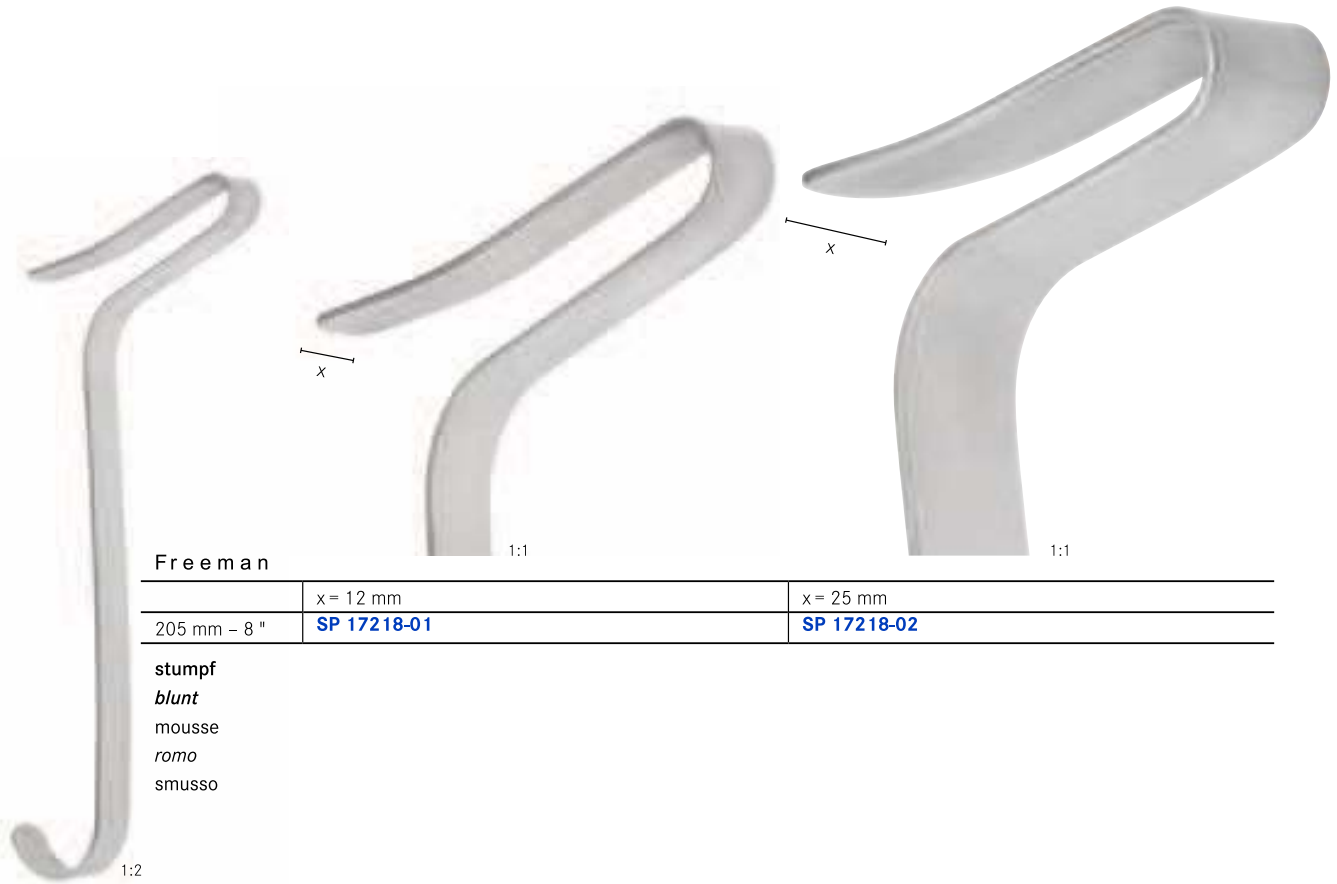

Freeman	x = 12 mm	x = 25 mm
205 mm – 8 "	SP 17218-01	SP 17218-02

stumpf
 blunt
 mousse
 romo
 smusso

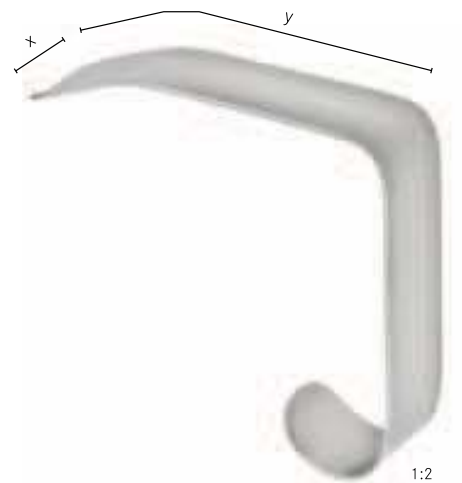

Ferreira	x = 23 mm / y = 120 mm
100 mm – 4 "	SP 17218-03

stumpf
 blunt
 mousse
 romo
 smusso



if you have any question or are interested in any of the products in this catalog please email info@surgpro.com

Weichteilhaken für die Kieferchirurgie
Soft tissue retractors for maxillo-facial surgery

Ecarteurs pour la chirurgie maxillo-faciale
Ganchos para cirugía maxilofacial
 Uncini per chirurgia massilofaciale

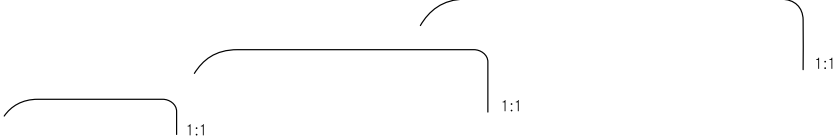

Obwegeser

	7 mm x 25 mm	10 mm x 42 mm	12 mm x 55 mm
215 mm - 8 ¹ / ₂ "	SP 17114-01	SP 17114-05	SP 17114-06

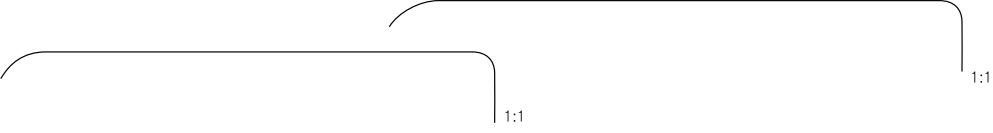

	14 mm x 70 mm	16 mm x 80 mm
215 mm - 8 ¹ / ₂ "	SP 17114-07	SP 17114-09

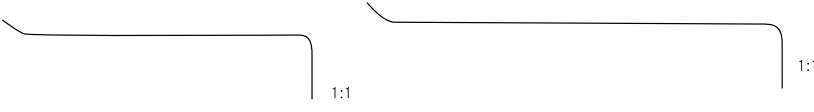

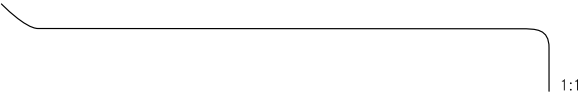

Obwegeser

	13 mm x 42 mm	12 mm x 60 mm
220 mm - 8 ³ / ₄ "	SP 52715-01	SP 52715-02

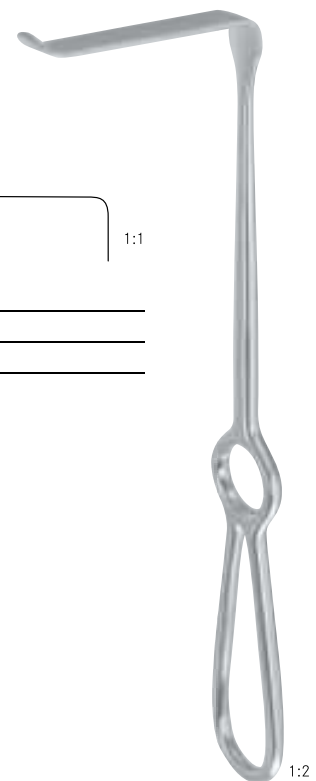

	16 mm x 80 mm
220 mm - 8 ³ / ₄ "	SP 52715-03



if you have any question or are interested in any of the products in this catalog please email info@surgpro.com

Weichteilhaken für die Kieferchirurgie
Soft tissue retractors for maxillo-facial surgery

Ecarteurs pour la chirurgie maxillo-faciale
Ganchos para cirugía maxilofacial
Uncini per chirurgia massilofaciale



1:2

Obwegeser

	44 mm x 9,5 mm	70 mm x 11,5 mm
220 mm - 8 ³ / ₄ "	SP 52717-22	SP 52719-22

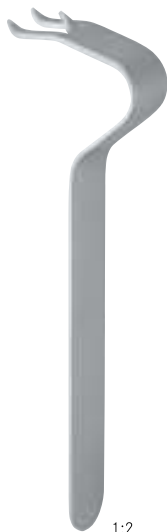

1:2

Obwegeser

155 mm - 6 "	SP 52723-16
--------------	--------------------



1:2

Obwegeser

	8 mm	10 mm
160 mm - 6 ¹ / ₄ "	SP 52725-08	SP 52725-10

biegsam
malleable
malléable
flexible
flessibile



if you have any question or are interested in any of the products in this catalog please email info@surgpro.com

Wundhaken - Wundsperrer
Retractors - Wound spreaders, self-retaining

Ecarteurs - Ecarteurs autostatiques
Separadores - Separadores autoestáticos
 Divaricatori - Divaricatori autostatici

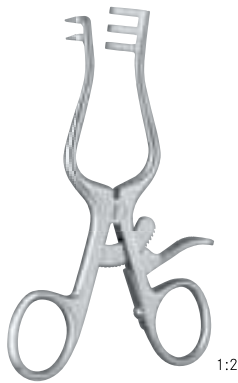

1:2

Weitlaner-Loktite

105 mm - 4 1/4 "	SP 17400-10	SP 17400-20	SP 17401-10
scharf	halbscharf	stumpf	
<i>sharp</i>	<i>semi sharp</i>	<i>blunt</i>	
pointu	semi pointu	mousse	
<i>agudo</i>	<i>semi agudo</i>	<i>romo</i>	
acuto	semi acuto	smusso	



Weitlaner-Loktite

130 mm - 5 "	SP 17402-13	SP 17402-23	SP 17403-13
165 mm - 6 1/2 "	SP 17402-16	SP 17402-26	SP 17403-16
200 mm - 8 "	SP 17404-20	SP 17404-30	SP 17405-20
260 mm - 10 1/4 "	SP 17404-26	SP 17404-36	SP 17405-26
scharf	halbscharf	stumpf	
<i>sharp</i>	<i>semi sharp</i>	<i>blunt</i>	
pointu	semi pointu	mousse	
<i>agudo</i>	<i>semi agudo</i>	<i>romo</i>	
acuto	semi acuto	smusso	



if you have any question or are interested in any of the products in this catalog please email info@surgpro.com

Wundhaken - Wundsperrer
Retractors - Wound spreaders, self-retaining

Ecarteurs - Ecarteurs autostatiques
Separadores - Separadores autoestáticos
 Divaricatori - Divaricatori autostatici

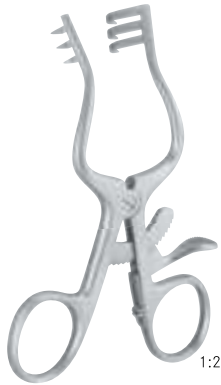

Wullstein

100 mm - 4 "

SP 17408-01

SP 17408-02

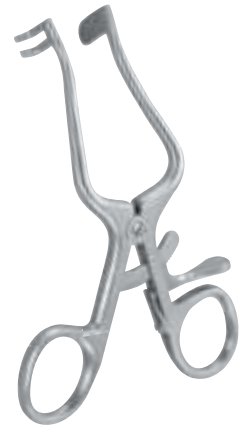
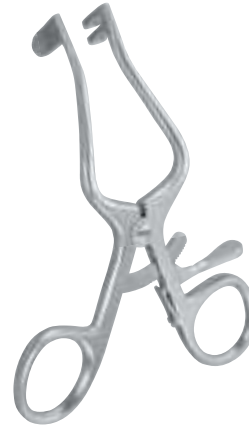

Belucci

110 mm - 4 1/4 "

SP 17410-11

SP 17411-11

130 mm - 5 "

SP 17410-13

SP 17411-13

links, stumpf
left, blunt
 gauche, mousse
izquierda, romo
 sinistra, smusso

rechts, stumpf
right, blunt
 droit, mousse
derecha, romo
 destra, smusso

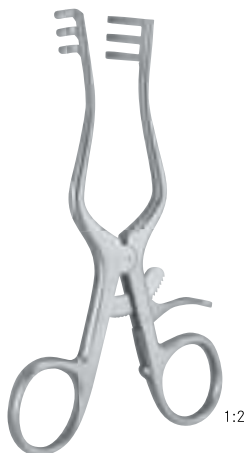

Miligan

130 mm - 5 "

SP 17409-13

stumpf
blunt
 mousse
romo
 smusso



Travers

205 mm - 8 1/2 "

SP 17412-20

stumpf
blunt
 mousse
romo
 smusso



if you have any question or are interested in any of the products in this catalog please email info@surgpro.com

Nadelhalter | Porte-aiguilles
 Needle holders | Porta-agujas
 Porta aghi

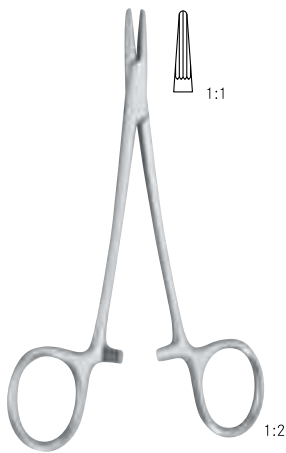

Derf
 125 mm – 5"
SP 20308-12

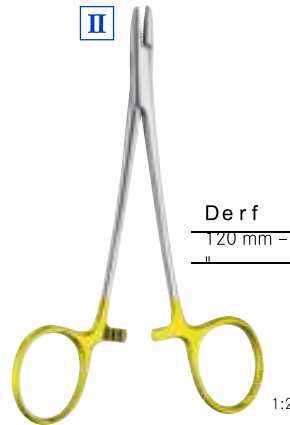

Derf
 120 mm – 4³/₄" | **SP 20008-12** | **SP 20508-12 TC**

ein Maul gefenstert
one fenestrated jaw
 une coté du mors fenestré
un lado de la boca fenestrada
 una parte del morso fi
 nestrado



Crile-Murray
 150 mm – 6" **SP 20001-15**



Crile-Wood
 150 mm – 6" | **SP 20002-15** | **SP 20502-15**
 180 mm – 7" | **SP 20002-18** | **TC SP 20502-**
 200 mm – 8" | **SP20002-20** | **18 TC SP**
20502-20 TC



if you have any question or are interested in any of the products in this catalog please email info@surgpro.com

Nadelhalter
Needle holders

Porte-aiguilles
Porta-agujas
Porta aghi

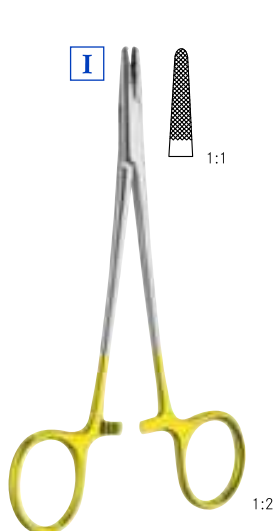

Hegar-Baumgartner

140 mm - 5 $\frac{3}{4}$ "	SP 20003-14
140 mm - 5 $\frac{3}{4}$ "	SP 20503-14 TC



Baby-Crile-Wood

150 mm - 6"	SP 20504-15 TC
-------------	-----------------------

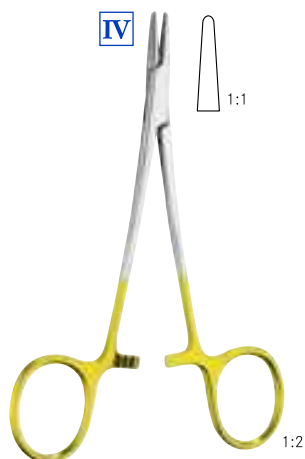

Webster

130 mm - 5"	SP 20009-13
130 mm - 5"	SP 20509-13 TC

glatt
smooth
lisse
liso
liscio



Mathieu-Olsen

140 mm - 5 $\frac{1}{2}$ "	SP 20106-14	SP 20516-14 TC
170 mm - 6 $\frac{3}{4}$ "	SP 20106-17	SP 20516-17 TC
200 mm - 8"	SP 20106-20	SP 20516-20 TC



if you have any question or are interested in any of the products in this catalog please email info@surgpro.com

Nadelhalter | Porte-aiguilles
 Needle holders | Porta-agujas
 Porta aghi

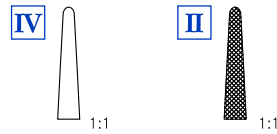

Halsey

130 mm - 5 "	SP 20010-13	SP 20011-13
130 mm - 5 "	SP 20510-13 TC	SP 20511-13 TC

glatt	gerieft
<i>smooth</i>	<i>serrated</i>
lisse	strié
<i>liso</i>	<i>estriada</i>
liscio	zigrinato

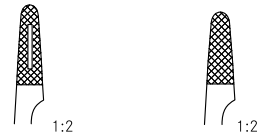

Olsen-Hegar

120 mm - 4 ³ / ₄ "	SP 20036-12	SP 20536-12 TC
140 mm - 5 ¹ / ₂ "	SP 20036-14	SP 20536-14 TC
170 mm - 6 ³ / ₄ "	SP 20036-17	SP 20536-17 TC
190 mm - 7 ¹ / ₂ "	SP 20036-19	SP 20536-19 TC



if you have any question or are interested in any of the products in this catalog please email info@surgpro.com

Nadelhalter | Porte-aiguilles
 Needle holders | Porta-agujas
 Porta aghi

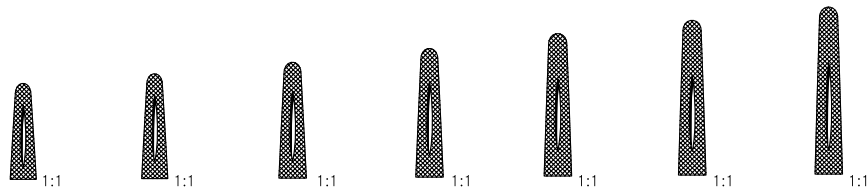

Mayo-Hegar

140 mm - 5 1/2"	160 mm - 6 1/4"	180 mm - 7"	200 mm - 8"	240 mm - 9 1/2"	260 mm - 10 1/4"	300 mm - 12"
SP 20012-14	SP 20012-16	SP 20012-18	SP 20012-20	SP 20012-24	SP 20012-26	SP 20012-30

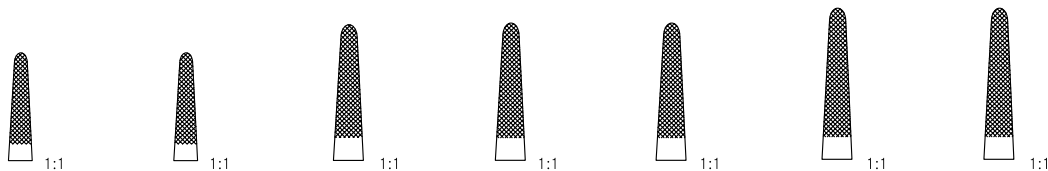

Mayo-Hegar

140 mm - 5 1/2"	160 mm - 6 1/4"	180 mm - 7"	200 mm - 8"	240 mm - 9 1/2"	260 mm - 10 1/4"	300 mm - 12"
SP 20512-14 TC	SP 20512-16 TC	SP 20512-18 TC	SP 20512-20 TC	SP 20512-24 TC	SP 20512-26 TC	SP 20512-30 TC



if you have any question or are interested in any of the products in this catalog please email info@surgpro.com

Nadelhalter | Porte-aiguilles
 Needle holders | Porta-agujas
 Porta aghi

II



Gillies

160 mm - 6 3/4"



1:1



1:1

SP 20035-16	SP 20535-16 TC
--------------------	-----------------------



Gillies

145 mm - 5 3/4"



1:1



1:1

SP 20035-14	SP 20535-14 TC
--------------------	-----------------------



Foster-Gillies

120 mm - 4 3/4"



1:2



1:2



1:2



1:2

SP 20546-12 TC	SP 20548-12 TC	SP 20547-12 TC	SP 20549-12 TC
-----------------------	-----------------------	-----------------------	-----------------------

gerade, gerieft
 straight, serrated
 droit, strié
 recta, estriada
 retto, zigrinato

gerade, glatt
 straight, smooth
 droit, lisse
 recta, lisa
 retto, liscio

gebogen, gerieft
 curved, serrated
 courbe, strié
 curva, estriada
 curvo, zigrinato

gebogen, glatt
 curved, smooth
 courbe, lisse
 curva, lisa
 curvo, liscio



if you have any question or are interested in any of the products in this catalog please email info@surgpro.com

Nadelhalter | Porte-aiguilles
 Needle holders | Porta-agujas
 Porta aghi

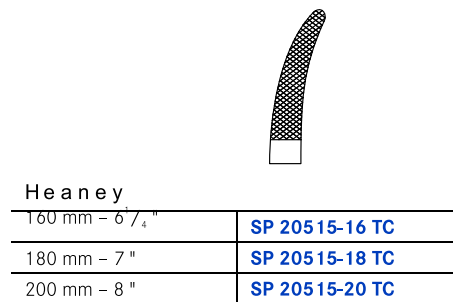
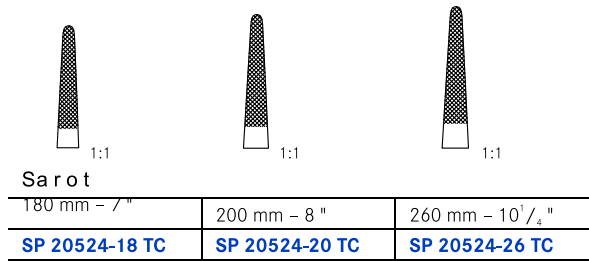
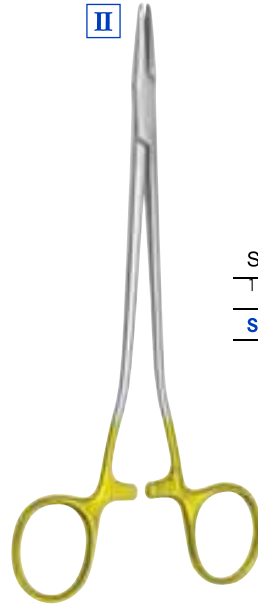
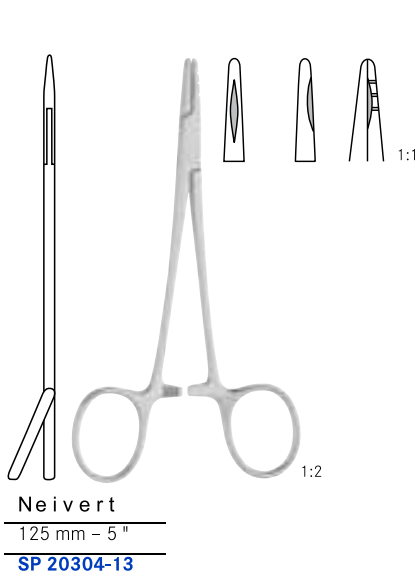

if you have any question or are interested in any of the products in this catalog please email info@surgpro.com

Nadelhalter | Porte-aiguilles
Needle holders | *Porta-agujas*
 Porta aghi

II

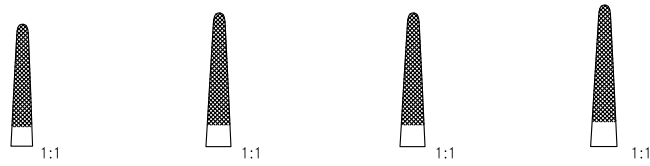

De Bakley

180 mm - 7"	200 mm - 8"	230 mm - 9"	260 mm - 10 ¹ / ₄ "
SP 20522-18 TC	SP 20522-20 TC	SP 20522-23 TC	SP 20522-26 TC

III

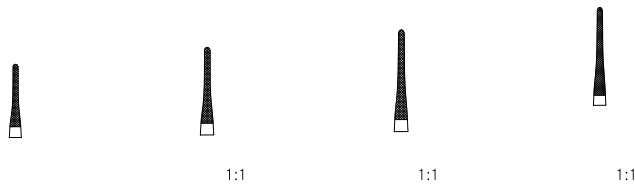

Vascular

140 mm - 5 ¹ / ₂ "	180 mm - 7"	200 mm - 8"	230 mm - 9"
SP 20525-14 TC	SP 20525-18 TC	SP 20525-20 TC	SP 20525-23 TC



if you have any question or are interested in any of the products in this catalog please email info@surgpro.com

Nadelhalter | Porte-aiguilles
Needle holders | Porta-agujas
 Porta aghi

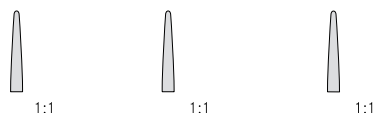

130 mm – 5 "	150 mm – 5 ³ / ₄ "	170 mm – 6 ³ / ₄ "
SP 20570-13	SP 20570-15	SP 20570-17

mit Spezialbeschichtung im Maul
with special coated jaw
 mors avec couche special
 boca con capa especial
 morso "diamant dust"

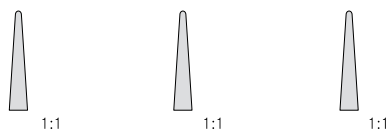

180 mm – 7 "	200 mm – 8 "	230 mm – 9 "
SP 20570-18	SP 20570-20	SP 20570-23

mit Spezialbeschichtung im Maul
with special coated jaw
 mors avec couche special
 boca con capa especial
 morso "diamant dust"



Beschichtung mit Hartmetallstaub.
 Sicheres Halten der Nadel
 Speziell geeignet für feine Nadelhalter, keine Bruchgefahr der Maulspitzen.

*Jaws coated with carbide dust.
 Secure fi xing of the needle.
 Suitable for delicate needle - holders, no risk of breakage of the jaws*

Mors recouverts de poussière de carbure.
 Tenu sûre de l'aiguille.
 Spécialement approprié pour des port - aiguilles fi ns, pas de risque des ruptures des mors.

*Bocas revestidas con polvo de carburo.
 Fija seguramente la aguja.
 Apto para porta - agujas delicados, ningún riesgo de roturas de las bocas.*

Morsi rivestiti con polvere di carburo.
 Regge sicuramente l'ago.
 Appropriato particolarmente per porta - aghi sottili, senza rischio per rottura di morso.



if you have any question or are interested in any of the products in this catalog please email info@surgpro.com

Nadelhalter | Porte-aiguilles
 Needle holders | Porta-agujas
 Porta aghi

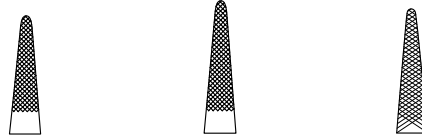

Lichtenberg

170 mm - 6 ³ / ₄ "	SP 20615-17 TC		SP 20115-17
200 mm - 8"		SP 20615-20 TC	SP 20115-20

III



Diethrich

160 mm - 6 ¹ / ₄ "	SP 20560-16 TC
180 mm - 7"	SP 20560-18 TC SP
200 mm - 8"	20560-20 TC SP
230 mm - 9"	20560-23 TC SP
250 mm - 9 ³ / ₄ "	20560-25 TC

II



Ryder

130 mm - 5"	SP 20540-13 TC SP	SP 20541-13
150 mm - 6"	20540-15 TC SP	SP 20541-15
180 mm - 7"	20540-18 TC SP	SP 20541-18
200 mm - 8"	20540-20 TC SP	SP 20541-20
230 mm - 9"	20540-23 TC SP	SP 20541-23
260 mm - 10 ¹ / ₄ "	20540-26 TC	

III



Mini-Ryde

SP 20542-13 TC
SP 20542-15 TC
SP 20542-18 TC
SP 20542-20 TC
SP 20542-23 TC
SP 20542-26 TC



mit Spezialbeschichtung im Maul
 with special coated jaw
 Mors avec couche special
 Boca con capa especial
 Morso "diamant dust"



if you have any question or are interested in any of the products in this catalog please email info@surgpro.com

Nadelhalter
Needle holders

Porte-aiguilles
Porta-agujas
Porta aghi

IV



Castroviejo-
Cacobson



140 mm - 5 1/2 "			SP 20210-14	SP 20710-14 TC
150 mm - 6 "	SP 20204-15	SP 20704-15 TC	SP 20210-15	SP 20710-15 TC
180 mm - 7 "	SP 20204-18	SP 20704-18 TC	SP 20210-18	SP 20710-18 TC
210 mm - 8 1/4 "	SP 20204-21	SP 20704-21 TC	SP 20210-21	SP 20710-21 TC

"
glattes Maul
smooth jaws
mors lisse
boca lisa
morso liscio

gerade, ohne Sperre
straight, without ratchet
droit, sans crémaillère
recta, sin cremallera
retto, senza cremagliera

gerade, mit Sperre
straight, with ratchet
droit, avec crémaillère
recta, con cremallera
retto, con cremagliera



140 mm - 5 1/2 "			SP 20211-14	SP 20711-14 TC
150 mm - 6 "	SP 20205-15	SP 20705-15 TC	SP 20211-15	SP 20711-15 TC
180 mm - 7 "	SP 20205-18	SP 20705-18 TC	SP 20211-18	SP 20711-18 TC
210 mm - 8 1/4 "	SP 20205-21	SP 20705-21 TC	SP 20211-21	SP 20711-21 TC

"
glattes Maul
smooth jaws
mors lisse
boca lisa
morso liscio

gebogen, ohne Sperre
curved, without ratchet
courbe, sans crémaillère
curva, sin cremallera
curvo, senza cremagliera

gebogen, mit Sperre
curved, with ratchet
courbe, avec crémaillère
curva, con cremallera
curvo, con cremagliera



1:2

Barraquer



1:1



1:1

145 mm - 5 3/4 "	SP 20200-14	SP 20201-14
------------------	-------------	-------------

gerade
straight
droit
recta
retto

gebogen
curved
courbe
curva
curvo



Mikronadelhalter | Micro porte aiguilles
 Micro needle holders | Micro porta agujas
 Micro porta aghi



Castroviejo

C = 11.0 mm x 0.75 mm

140 mm - 5 ¹ / ₂ "	SP 40910-14	SP 40911-14	SP 40912-14	SP 40913-14
--	--------------------	--------------------	--------------------	--------------------

ohne Sperre, feines Maul <i>without ratchet, fine jaws</i> sans crémaillère, mors fine <i>sin cremallera, boca fina</i> senza cremagliera, morso fino	gerade <i>straight</i> droit <i>recta</i> retto	gebogen <i>curved</i> courbe <i>curva</i> curvo	gerade, diamantiert <i>straight, diamond coated</i> droit, diamanté <i>recta, diamantada</i> retto, diamantato	gebogen, diamantiert <i>curved, diamond coated</i> courbe, diamanté <i>curva, diamantada</i> curvo, diamantato
---	---	---	--	--

x = 11.0 mm x 0.75 mm				
140 mm - 5 ¹ / ₂ "	SP 40915-14	SP 40917-14	SP 40918-14	SP 40919-14

mit Sperre, feines Maul <i>with ratchet, fine jaws</i> avec crémaillère, mors fine <i>con cremallera, boca fina</i> con cremagliera, morso fino	gerade <i>straight</i> droit <i>recta</i> retto	gebogen <i>curved</i> courbe <i>curva</i> curvo	gerade, diamantiert <i>straight, diamond coated</i> droit, diamanté <i>recta, diamantada</i> retto, diamantato	gebogen, diamantiert <i>curved, diamond coated</i> courbe, diamanté <i>curva, diamantada</i> curvo, diamantato
---	---	---	--	--







1:1







if you have any question or are interested in any of the products in this catalog please email info@surgpro.com

Mikronadelhalter | Micro porte aiguilles
Micro needle holders | Micro porta agujas
 Micro porta aghi



Jacobson	 1:1	 1:1	 1:1	 1:1
	x = 1 mm	x = 1 mm	x = 1 mm	x = 1 mm
180 mm – 7"	SP 25740-01	SP 25740-02	SP 25740-13	SP 25740-14
ohne Sperre <i>without ratchet</i>	gerade <i>straight</i>	gebogen <i>curved</i>	gerade, diamantiert <i>straight, diamond coated</i>	gebogen, diamantiert <i>curved, diamond coated</i>
sans crémaillère <i>sin cremallera</i>	droit <i>recta</i>	courbe <i>curva</i>	droit, diamanté <i>recta, diamantada</i>	courbe, diamanté <i>curva, diamantada</i>
senza cremagliera	retto	curvo	retto, diamantato	curvo, diamantato

	x = 1 mm	x = 1 mm	x = 1 mm	x = 1 mm
180 mm – 7"	SP 25740-03	SP 25740-04	SP 25740-15	SP 25740-16
mit Sperre <i>with ratchet</i>	gerade <i>straight</i>	gebogen <i>curved</i>	gerade, diamantiert <i>straight, diamond coated</i>	gebogen, diamantiert <i>curved, diamond coated</i>
avec crémaillère <i>con cremallera</i>	droit <i>recta</i>	courbe <i>curva</i>	droit, diamanté <i>recta, diamantada</i>	courbe, diamanté <i>curva, diamantada</i>
con cremagliera	retto	curvo	retto, diamantato	curvo, diamantato

	 1:1	 1:1	 1:1	 1:1
	x = 1 mm	x = 1 mm	x = 1 mm	x = 1 mm
180 mm – 7"	SP 25740-05 tucar	SP 25740-06 tucar	SP 25740-09 tucar	SP 25740-10 tucar
ohne Sperre <i>without ratchet</i>	gerade, glatt <i>straight, smooth</i>	gebogen, glatt <i>curved, smooth</i>	gerade, gerieft <i>straight, serrated</i>	gebogen, gerieft <i>curved, serrated</i>
sans crémaillère <i>sin cremallera</i>	droit, lisse <i>recta, liso</i>	courbe, lisse <i>curva, lisa</i>	droit, strié <i>recta, estriada</i>	courbe, strié <i>curva, estriada</i>
senza cremagliera	retto, liscio	curvo, liscio	retto, zigrinato	curvo, zigrinato





180 mm – 7"	SP 25740-07 tucar	SP 25740-08 tucar	SP 25740-11 tucar	SP 25740-12 tucar
1 mm				
mit Sperre <i>with ratchet</i>	gerade, glatt <i>straight, smooth</i>	gebogen, glatt <i>curved, smooth</i>	gerade, gerieft <i>straight, serrated</i>	gebogen, gerieft <i>curved, serrated</i>
avec crémaillère <i>con cremallera</i>	droit, lisse <i>recta, liso</i>	courbe, lisse <i>curva, lisa</i>	droit, strié <i>recta, estriada</i>	courbe, strié <i>curva, estriada</i>
con cremagliera	retto, liscio	curvo, liscio	retto, zigrinato	curvo, zigrinato



if you have any question or are interested in any of the products in this catalog please email info@surgpro.com

Mikronadelhalter mit Rundgriff | Micro porte aiguilles avec manche ronde
Micro needle holders with round handle | Micro porta agujas con mango redondo
 Micro porta aghi con manico rotondo



Barraquer		 1:1	 1:1	 1:1	 1:1
140 mm - 5 1/2"	8 mm Ø	SP 25622-01	SP 25622-02	SP 25622-05	SP 25622-06
ohne Sperre, sehr feines Maul <i>without ratchet, extra delicate jaws</i>	gerade <i>straight</i>	gebogen <i>curved</i>	gerade, diamantiert <i>straight, diamond coated</i>	gebogen, diamantiert <i>curved, diamond coated</i>	
sans crémaillère, mors très fine <i>sin cremallera, boca muy fina</i>	droit <i>recta</i>	courbe <i>curva</i>	droit, diamanté <i>recta, diamantada</i>	courbe, diamanté <i>curva, diamantada</i>	
senza cremagliera, morso molto fino	retto	curvo	retto, diamantato	curvo, diamantato	
140 mm - 5 1/2"	8 mm Ø	SP 25622-03	SP 25622-04	SP 25622-07	SP 25622-08
mit Sperre, sehr feines Maul <i>with ratchet, extra delicate jaws</i>	gerade <i>straight</i>	gebogen <i>curved</i>	gerade, diamantiert <i>straight, diamond coated</i>	gebogen, diamantiert <i>curved, diamond coated</i>	
avec crémaillère, mors très fine <i>con cremallera, boca muy fina</i>	droit <i>recta</i>	courbe <i>curva</i>	droit, diamanté <i>recta, diamantada</i>	courbe, diamanté <i>curva, diamantada</i>	
con cremagliera, morso molto fino	retto	curvo	retto, diamantato	curvo, diamantato	



if you have any question or are interested in any of the products in this catalog please email info@surgpro.com

Mikronadelhalter mit Rundgriff
Micro needle holders with round handle

Micro porte aiguilles avec manche ronde
 Micro porta agujas con mango redondo
 Micro porta aghi con manico rotondo



110 mm - 4 ¹ / ₄ "	8 mm Ø	SP 25637-11	SP 25638-11
125 mm - 5 "	7 mm Ø	SP 25654-12	SP 25655-12
130 mm - 5 "	8 mm Ø 10	SP 25658-13	SP 25659-13
130 mm - 5 "	mm Ø	SP 25652-13	SP 25653-13
150 mm - 6 "	8 mm Ø	SP 25640-15	SP 25641-15
180 mm - 7 "	8 mm Ø 10	SP 25664-18	SP 25665-18
180 mm - 7 "	mm Ø	SP 25668-18	SP 25669-18

ohne Sperre
without ratchet
 sans crémaillère
sin cremallera
 senza cremagliera

gerade
straight
 droit
recta
 retto

gebogen
curved
 courbe
curva
 curvo

110 mm - 4 ¹ / ₄ "	8 mm Ø	SP 25635-11	SP 25636-11
125 mm - 5 "	7 mm Ø	SP 25656-12	SP 25657-12
130 mm - 5 "	8 mm Ø 10	SP 25662-13	SP 25663-13
130 mm - 5 "	mm Ø	SP 25645-13	SP 25646-13
150 mm - 6 "	8 mm Ø	SP 25642-15	SP 25643-15
180 mm - 7 "	8 mm Ø 10	SP 25666-18	SP 25667-18
180 mm - 7 "	mm Ø	SP 25670-18	SP 25671-18

mit Sperre
with ratchet
 avec crémaillère
con cremallera
 con cremagliera

gerade
straight
 droit
recta
 retto





gebogen
curved
 courbe
curva
 curvo







if you have any question or are interested in any of the products in this catalog please email info@surgpro.com

Mikronadelhalter mit Rundgriff | Micro porte aiguilles avec manche ronde
Micro needle holders with round handle | Micro porta agujas con mango redondo
 Micro porta aghi con manico rotondo



Yasargil	 1:1	 1:1	 1:1	 1:1
	x = 1 mm	x = 1 mm	x = 1 mm	x = 1 mm
210 mm - 8 1/4"	SP 25623-01	SP 25623-02	SP 25623-13	SP 25623-14
ohne Sperre <i>without ratchet</i>	gerade <i>straight</i>	gebogen <i>curved</i>	gerade, diamantiert <i>straight, diamond coated</i>	gebogen, diamantiert <i>curved, diamond coated</i>
sans crémaillère <i>sin cremallera</i>	droit <i>recta</i>	courbe <i>curva</i>	droit, diamanté <i>recta, diamantado</i>	courbe, diamanté <i>curva, diamantado</i>
senza cremagliera <i>retto</i>	retto	curvo	retto, diamantato	curvo, diamantato
	x = 1 mm	x = 1 mm	x = 1 mm	x = 1 mm
210 mm - 8 1/4"	SP 25623-03	SP 25623-04	SP 25623-15	SP 25623-16
mit Sperre <i>with ratchet</i>	gerade <i>straight</i>	gebogen <i>curved</i>	gerade, diamantiert <i>straight, diamond coated</i>	gebogen, diamantiert <i>curved, diamond coated</i>
avec crémaillère <i>con cremallera</i>	droit <i>recta</i>	courbe <i>curva</i>	droit, diamanté <i>recta, diamantada</i>	courbe, diamanté <i>curva, diamantada</i>
con cremagliera <i>retto</i>	retto	curvo	retto, diamantato	curvo, diamantato

	 1:1	 1:1	 1:1	 1:1
	x = 1 mm	x = 1 mm	x = 1 mm	x = 1 mm
210 mm - 8 1/4"	SP 25623-05 tucar	SP 25623-06 tucar	SP 25623-09 tucar	SP 25623-10 tucar
ohne Sperre <i>without ratchet</i>	gerade, glatt <i>straight, smooth</i>	gebogen, glatt <i>curved, smooth</i>	gerade, gerieft <i>straight, serrated</i>	gebogen, gerieft <i>curved, serrated</i>
sans crémaillère <i>sin cremallera</i>	droit, lisse <i>recta, lisa</i>	courbe, lisse <i>curva, lisa</i>	droit, strié <i>recta, estriada</i>	courbe, strié <i>curva, estriada</i>
senza cremagliera <i>retto</i>	retto, liscio	curvo, liscio	retto, zigrinato	curvo, zigrinato
	x = 1 mm	x = 1 mm	x = 1 mm	x = 1 mm
210 mm - 8 1/4"	SP 25623-07 tucar	SP 25623-08 tucar	SP 25623-11 tucar	SP 25623-12 tucar
mit Sperre <i>with ratchet</i>	gerade, glatt <i>straight, smooth</i>	gebogen, glatt <i>curved, smooth</i>	gerade, gerieft <i>straight, serrated</i>	gebogen, gerieft <i>curved, serrated</i>
avec crémaillère <i>con cremallera</i>	droit, lisse <i>recta, lisa</i>	courbe, lisse <i>curva, lisa</i>	droit, strié <i>recta, estriada</i>	courbe, strié <i>curva, estriada</i>
con cremagliera <i>retto</i>	retto, liscio	curvo, liscio	retto, zigrinato	curvo, zigrinato



Auf Anfrage mit kräftigem Maul 1.5 mm - 2.0 mm lieferbar.
 On request also available with stronger jaw 1.5 mm - 2.0 mm.
 Egalement disponible avec mors plus gros 1.5 mm - 2.0 mm.
 También disponible con boca mas fuerte 1.5 mm - 2.0 mm.
 A richiesta fornibile anche con morso più forte di mm 1.5 a mm 2.0.



if you have any question or are interested in any of the products in this catalog please email info@surgpro.com

Mikronadelhalter | Micro porte aiguilles
Micro needle holders | *Micro porta agujas*
 | *Micro porta aghi*



	0.4 x 0.6 mm	0.4 x 0.6 mm	0.6 x 0.6 mm	0.6 x 0.6 mm
200 mm - 8 "	SP 25685-13	SP 25685-14	SP 25685-15	SP 25685-16

Titan, mit Sperre
Titanium, with ratchet
 Titane, avec crémaillère
Titanio, con cremallera
 Titanio, con cremagliera



if you have any question or are interested in any of the products in this catalog please email info@surgpro.com

Mikronadelhalter | Micro porte aiguilles
Micro needle holders | *Micro porta agujas*
 Micro porta aghi



	0.3 mm x 0.4 mm	0.3 mm x 0.4 mm
180 mm – 7"	SP 25685-07	SP 25685-08

Titan, mit Sperre
Titanium, with ratchet
 Titane, avec crémaillère
 Titano, con cremallera
 Titanio, con cremagliera



	0.8 mm x 0.8 mm	0.8 mm x 0.8 mm
185 mm – 7 1/4"	SP 25685-09	SP 25685-10

Titan, mit Sperre
Titanium, with ratchet
 Titane, avec crémaillère
 Titano, con cremallera
 Titanio, con cremagliera



if you have any question or are interested in any of the products in this catalog please email info@surgpro.com

Hämmer	Maillets
Mallets	Martillos
	Martelli

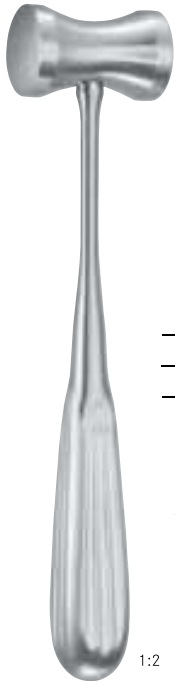

1:2

Hajek

	27 mm Ø - 140 g
215 mm - 8 ¹ / ₂ "	SP 24047-21

Stahl massiv
Steel solid
 Acier solide
 Acero solido
 Acciaio massiccio



1:2

Collin

	30 mm Ø - 220 g
200 mm - 8"	SP 24051-20

Stahl massiv
Steel solid
 Acier solide
 Acero solido
 Acciaio massiccio

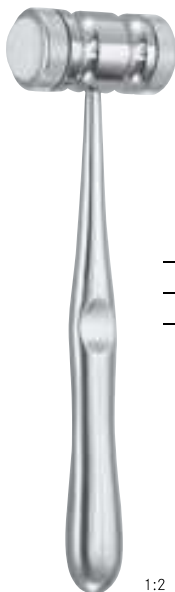

1:2

Mead

	26 mm Ø - 320 g	26 mm Ø - 320 g
170 mm - 6 ³ / ₄ "	SP 24050-17	SP 24050-90

Stahl massiv, mit Ferrozellbacken	Ersatzbacken, 1 Paar
<i>Steel solid, with Ferrozell faces</i>	<i>Spare faces, 1 pair</i>

Acier solide, avec plaques en Ferrozell Plaques de rechange, 1 paire
 Acero solido, con placas en Ferrozell Placas de cambio, 1 par
 Acciaio massiccio, con punte di Ferrozell Placche di ricambio, 1 paio



if you have any question or are interested in any of the products in this catalog please email info@surgpro.com

Hämmer
Mallets

Maillets
Martillos
Martelli



Partsch

	22 mm Ø – 200 g
180 mm – 7"	SP 24053-18

1:2



1:2

	20 mm Ø – 140 g
165 mm – 6 1/2"	SP 24055-16

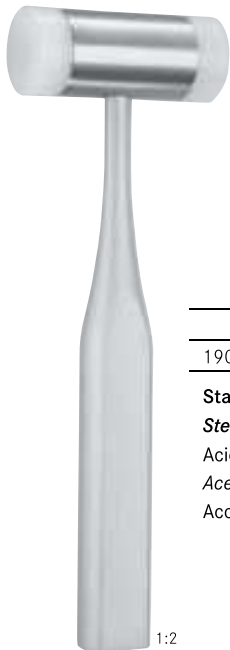

1:2

	25 mm Ø – 205 g
190 mm – 7 1/2"	SP 24056-19

Stahl massiv, mit Kunststoffbacken
Steel solid, with plastic faces
Acier solide, avec plaques en plastic
Acero sólido, con placas en plastica
Acciaio massiccio, con placche di plastica

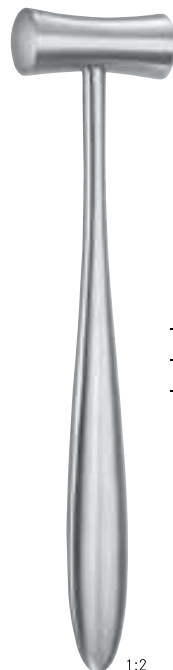

1:2

Lucae

	19 mm Ø – 230 g	25 mm Ø – 260 g
190 mm – 7 1/2"	SP 24057-01	SP 24057-02

Stahl massiv
Steel solid
Acier solide
Acero sólido
Acciaio massiccio



if you have any question or are interested in any of the products in this catalog please email info@surgpro.com

Meißel zur Nasenplastik
Chisels, osteotomes for rhinoplastic

Ostéotomes, ciseaux-burins pour rhinoplastique
Cinceles para rinoplastica
 Scalpelli per plastica nasale



Kilian

	5 mm
160 mm – 6¼"	SP 24261-16
"	



Kilian-Clau

	5 mm
160 mm – 6¼"	SP 24263-16
"	

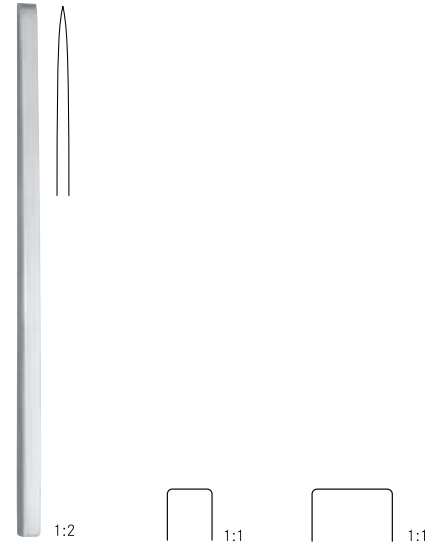

Cottle

	7 mm	12 mm
150 mm – 6"	SP 24270-07	SP 24270-12
"		



Cottle

	4 mm
190 mm – 7½"	SP 24272-19
"	



Cottle

	6 mm
180 mm – 7"	SP 24277-06
"	



if you have any question or are interested in any of the products in this catalog please email info@surgpro.com

Meißel zur Nasenplastik
Chisels, osteotomes for rhinoplastic

Ostéotomes, ciseaux-burins pour rhinoplastique
Cinceles para rinoplastica
 Scalpelli per plastica nasale



Cottle				
	4 mm	7 mm	9 mm	12 mm
180 mm - 7"	SP 24280-04	SP 24280-07	SP 24280-09	SP 24280-12



Cottle				
	4 mm	7 mm	9 mm	12 mm
180 mm - 7"	SP 24281-04	SP 24281-07	SP 24281-09	SP 24281-12



if you have any question or are interested in any of the products in this catalog please email info@surgpro.com

Meißel zur Nasenplastik
Chisels, osteotomes for rhinoplastic

Ostéotomes, ciseaux-burins pour rhinoplastique
Cinceles para rinoplastica
Scalpelli per plastica nasale



1:2

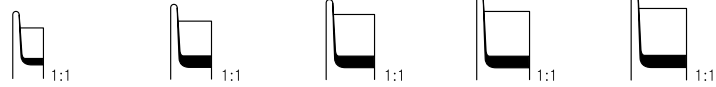

Fomon

	4 mm	5 mm	6 mm	7 mm	8 mm
170 mm – 6 ³ / ₄ "	SP 24278-04	SP 24278-05	SP 24278-06	SP 24278-07	SP 24278-08



1:2

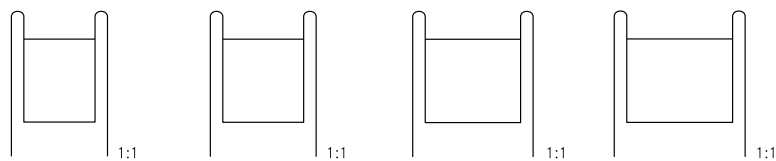

Cinelli

	10 mm	12 mm	14 mm	16 mm
180 mm – 7"	SP 24279-10	SP 24279-12	SP 24279-14	SP 24279-16



if you have any question or are interested in any of the products in this catalog please email info@surgpro.com

Meißel zur Nasenplastik
Chisels, osteotomes for rhinoplastic

Ostéotomes, ciseaux-burins pour rhinoplastique
Cinceles para rinoplastica
 Scalpelli per plastica nasale

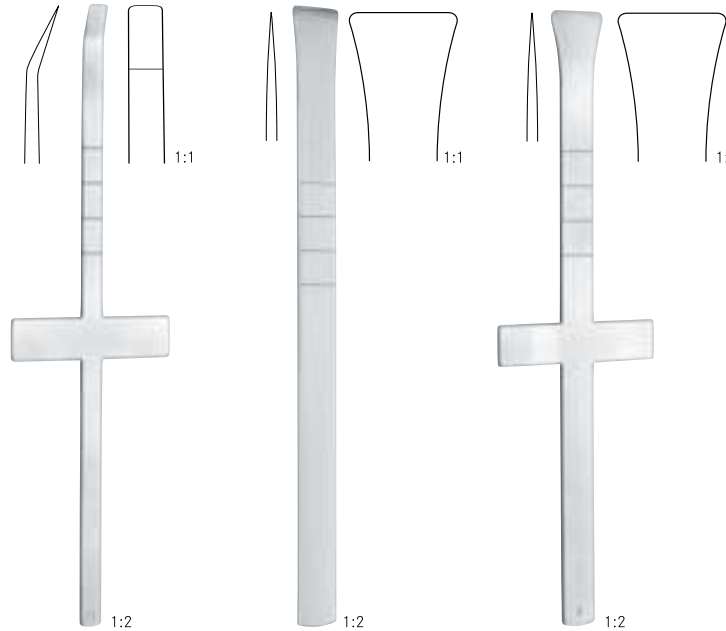

Cottle

	6 mm	16 mm	16 mm
180 mm - 7"	SP 24283-06	SP 24284-16	SP 24286-16

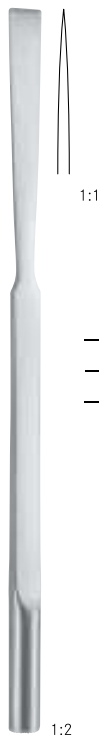

Cottle

	4 mm	7 mm	9 mm	12 mm
200 mm - 8"	SP 24287-04	SP 24287-07	SP 24287-09	SP 24287-12



if you have any question or are interested in any of the products in this catalog please email info@surgpro.com

Meißel zur Nasenplastik
Chisels, osteotomes for rhinoplastic

Ostéotomes, ciseaux-burins pour rhinoplastique
Cinceles para rhinoplastica
 Scalpelli per plastica nasale



1:2

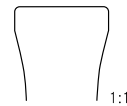
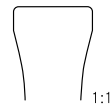
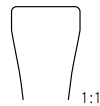

Rubin

10 mm		12 mm	14 mm
180 mm - 7"	SP 24290-10	SP 24290-12	SP 24290-14



1:2

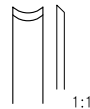
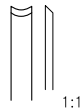

Walter

	3 mm	4,5 mm
190 mm - 7 1/2"	SP 24292-03	SP 24292-04



if you have any question or are interested in any of the products in this catalog please email info@surgpro.com

Meißel zur Nasenplastik
Chisels, osteotomes for rhinoplastic

Ostéotomes, ciseaux-burins pour rhinoplastique
Cinceles para rinoplastica
 Scalpelli per plastica nasale



1:2

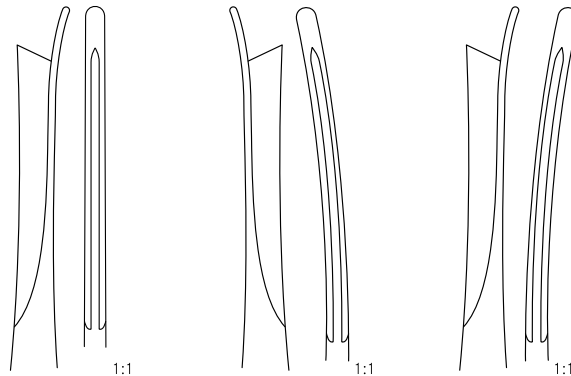

Silver

180 mm - 7"	SP 24296-01	SP 24296-02	SP 24296-03
<i>gerade</i> <i>straight</i> droit <i>recta</i> rette	<i>rechts</i> <i>right</i> droite <i>derecha</i> destra	<i>links left</i> gauche <i>izquierda</i> sinistra	



1:2

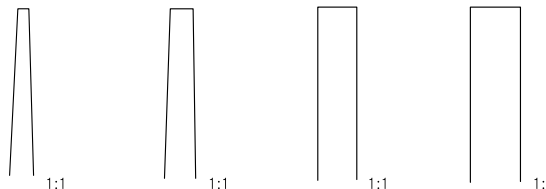

Sheehan

	2 mm	4 mm	6 mm	8 mm
160 mm - 6 1/4"	SP 24295-02	SP 24295-04	SP 24295-06	SP 24295-08

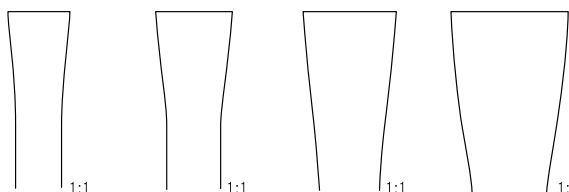

	10 mm	12 mm	15 mm	18 mm
160 mm - 6 1/4"	SP 24295-10	SP 24295-12	SP 24295-15	SP 24295-18



if you have any question or are interested in any of the products in this catalog please email info@surgpro.com

Meißel zur Nasenplastik
Chisels, osteotomes for rhinoplastic

Ostéotomes, ciseaux-burins pour rhinoplastique
Cinceles para rhinoplastica
Scalpelli per plastica nasale

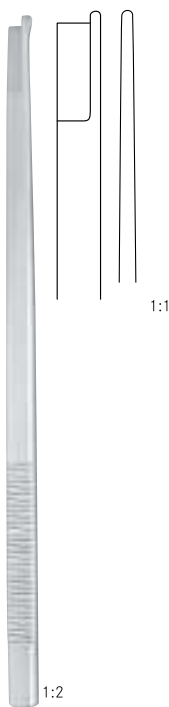

Neivert
200 mm – 8" **SP**
24298-01
gerade *straight*
droit *recta* rette

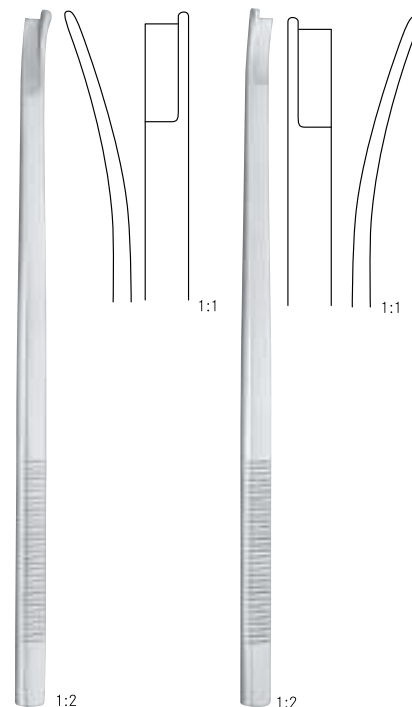

Neivert-Anderson
200 mm – 8"

SP 24298-02	SP 24298-03
rechts <i>right</i> droite <i>derecha</i> destra	links <i>left</i> gauche <i>izquierda</i> sinistra



if you have any question or are interested in any of the products in this catalog please email info@surgpro.com

Septum-Elevatorien
Septum elevators

Elevateurs pour la cloison nasale
Elevadores para el tabique nasal
Elevatori per setto

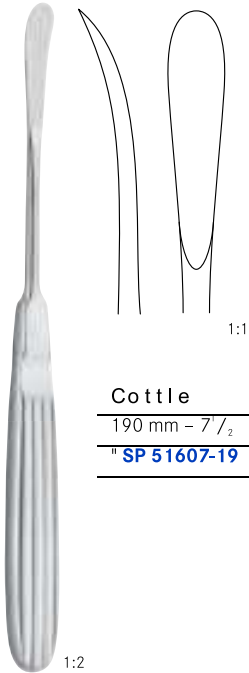

Cottle

190 mm - 7 1/2"

" **SP 51607-19**

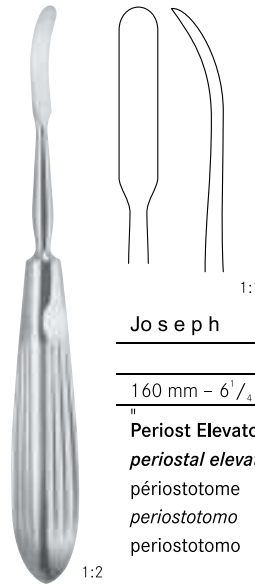

Joseph

4 mm

160 mm - 6 1/4"

SP 51613-16

" **Periost Elevatorium**

periostal elevator

périostotome

periostotomo

periototomo



Halle

160 mm - 6 1/4"

" **SP 51617-16**



Ballenger-Hajek

190 mm - 7 1/2"

SP 51637-19

220 mm - 8 3/4"

SP 51637-22



if you have any question or are interested in any of the products in this catalog please email info@surgpro.com

Septum-Elevatorien | Elevateurs pour la cloison nasale
Septum elevators | *Elevadores para el tabique nasal*
 Elevatori per setto



Freer
 190 mm - 7 1/2"
SP 51625-19
 stumpf *blunt*
 mousse *roma*
 smussa

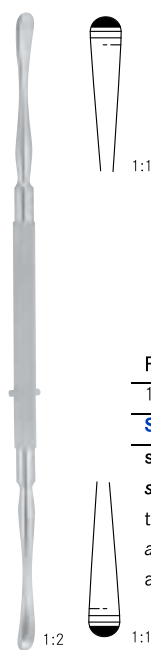

Freer
 180 mm - 7"
SP 51627-18
 scharf/stumpf
sharp/blunt
 tranchant/mousse
aguda/roma
 acuta/smussa

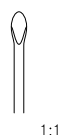

Cottle
 2.5 mm
 160 mm - 6 1/4"
SP 51646-02



if you have any question or are interested in any of the products in this catalog please email info@surgpro.com

Septum-Elevatorien
Septum elevators

Elevateurs pour la cloison nasale
Elevadores para el tabique nasal
Elevatori per setto



200 mm – 8 " | **SP 51645-20**

Saug-Raspatorium – biegsam, scharf
suction raspatory – malleable, sharp
rugine aspirante – fl exible, tranchant
legra aspiradora – maleable y agudo
elevatore-aspiratore – fl essibile,
tagliente

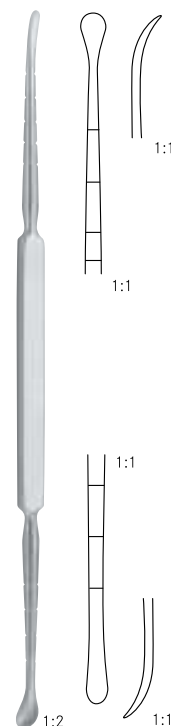

Cottle

210 mm – 8 1/4 "

" SP 51644-21



if you have any question or are interested in any of the products in this catalog please email info@surgpro.com

Septum-Elevatorien | Elevateurs pour la cloison nasale
Septum elevators | *Elevadores para el tabique nasal*
Elevatori per setto

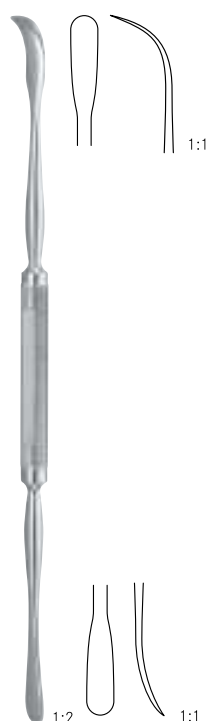

Freer

205 mm – 8"

SP 51631-20

scharf/stumpf

sharp/blunt

tranchant/mouss

e aguda/roma

acuta/smussa



Masing

200 mm – 8" **SP**

51636-21



Cottle

220 mm – 8³/₄"

SP 51643-22



if you have any question or are interested in any of the products in this catalog please email info@surgpro.com

Raspatorien und Ahlen für die Kieferchirurgie
Periosteal elevators and awls for maxillo-facial surgery

Rugines, décolleurs et passe-fils pour chirurgie maxillo-faciale
 Periostótomos y leznas para maxilofacial
 Raspatori, punteruoli per chirurgia massilofaciale

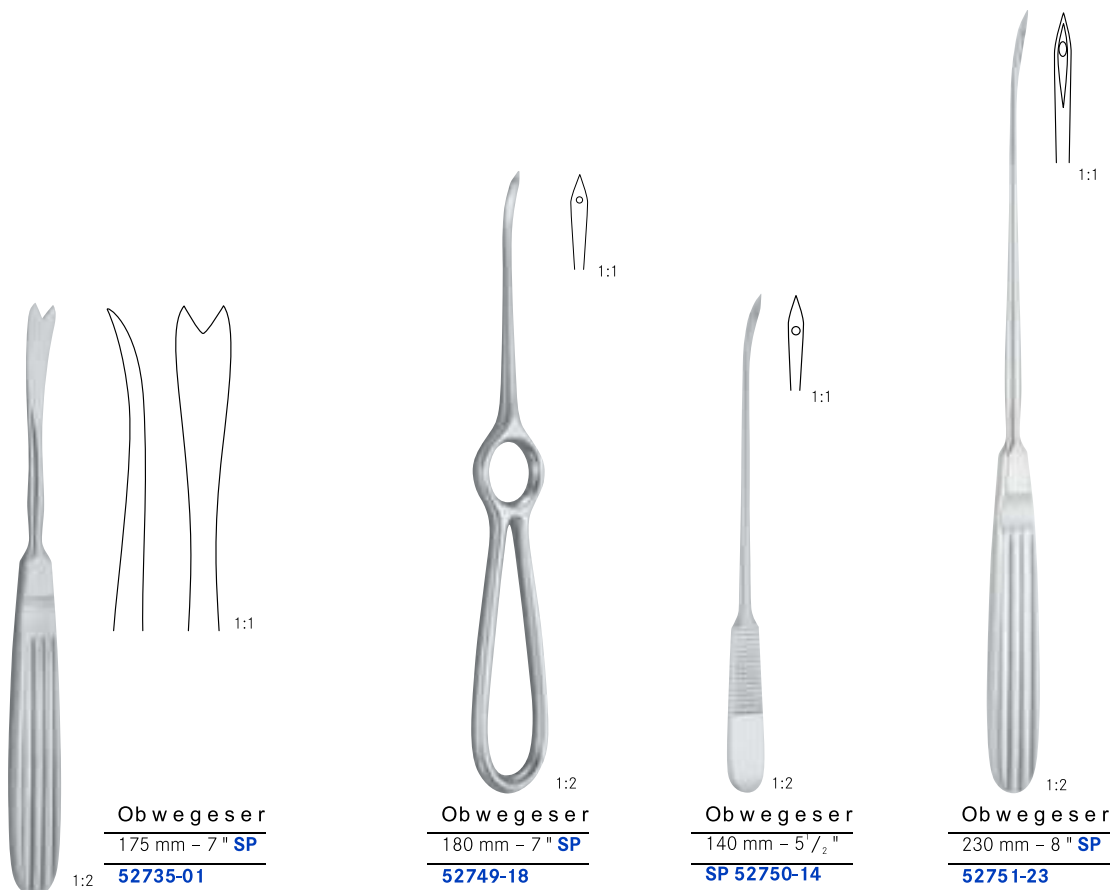
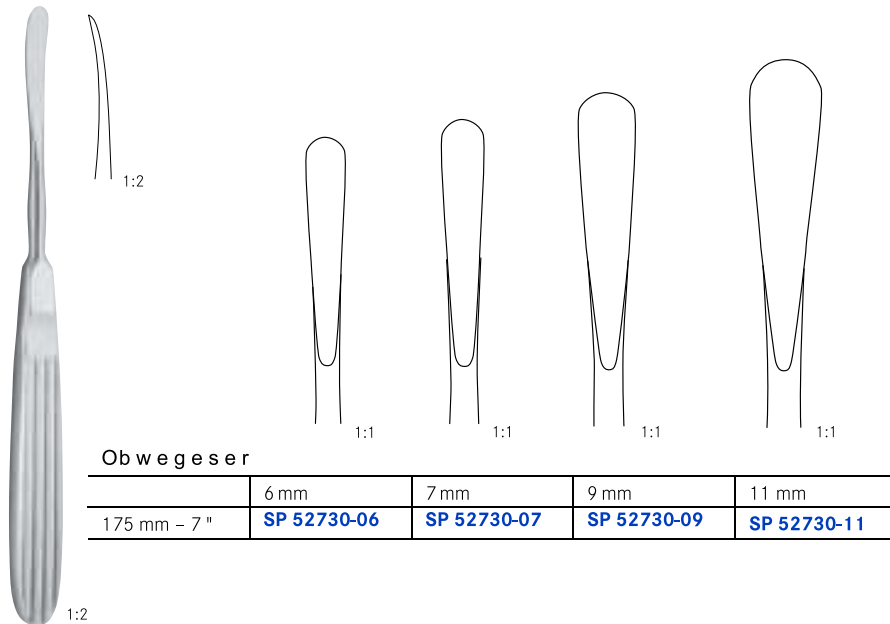

if you have any question or are interested in any of the products in this catalog please email info@surgpro.com

Raspatorien - Elevatorien | Rugines - Elevateurs
Periosteal raspatories - Elevators | *Raspatorios - Elevadores*
Periostotomi - Elevatori

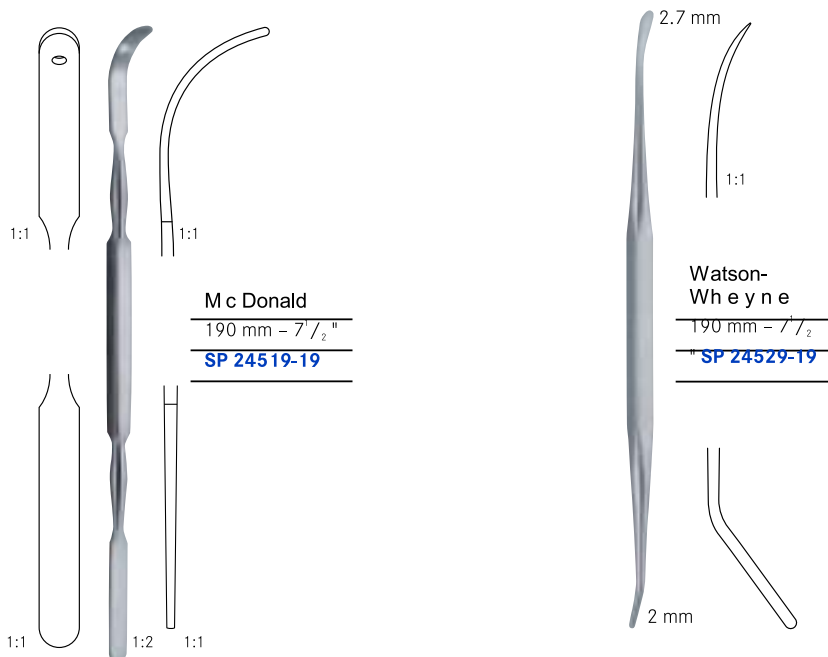

if you have any question or are interested in any of the products in this catalog please email info@surgpro.com

Meißel für die Kieferchirurgie
Osteotomes for maxillo-facial surgery

Ostéotomes pour chirurgie maxillo-faciale
Cinceles para maxilofacial
 Scalpelli per chirurgia massilofaciale

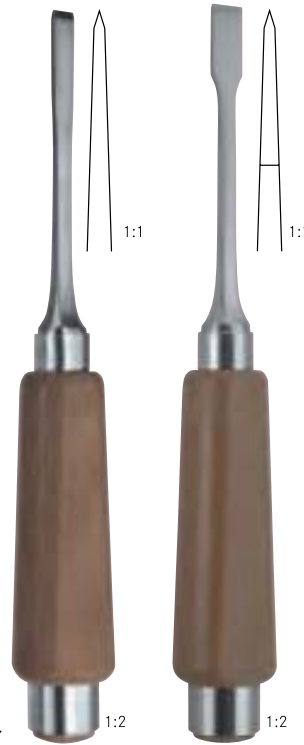

Obwegeser

	7 mm	10 mm
215 mm – 8 1/2 "	SP 52755-21	SP 52756-21

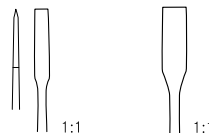

Obwegeser

	2,5 mm	4 mm
150 mm – 6 "	SP 52742-25	SP 52742-40



if you have any question or are interested in any of the products in this catalog please email info@surgpro.com

Raspatorien, Meißel für die Kieferchirurgie
Periosteal elevators, osteotomes for maxillo-facial surgery

Rugines, ostéotomes pour chirurgie maxillo-faciale
Periostótomos, cinceles para maxilofacial Raspatori,
 scalpelli per chirurgia massilofaciale

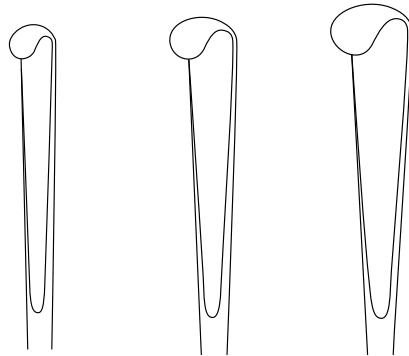

Obwegeser

	5 mm	8 mm	9 mm
200 mm – 8"	SP 52731-05	SP 52731-08	SP 52731-09



Obwegeser

210 mm – 8 1/4"
SP 52738-21



Obwegeser

210 mm – 8 1/4"
SP 52740-21



Obwegeser

235 mm – 9 1/4" x
= 11 mm
SP 52744-24



Obwegeser

185 mm – 7 1/4"
SP 52746-19



Obwegeser

185 mm – 7 1/4"
SP 52747-19



if you have any question or are interested in any of the products in this catalog please email info@surgpro.com

Nasenspekula
Nasal specula

Spéculums nasaux
Espéculos nasales
Specoli nasali

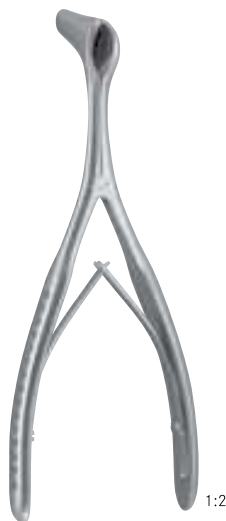

1:2

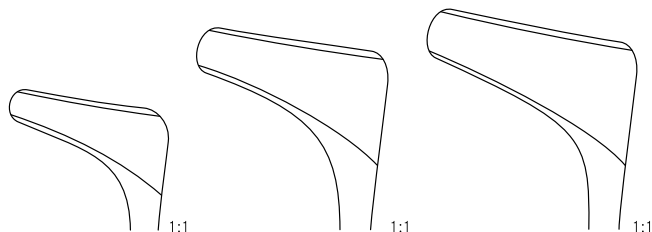

Hartmann-Halle

150 mm – 6"

SP 50813-

SP 50813-02

SP 50813-03

01

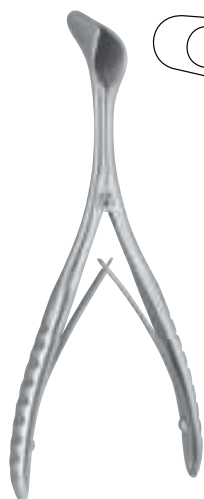

1:2

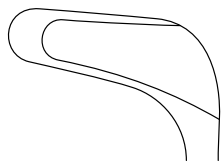

1:1

Schwarz

140 mm – 5 1/2"

SP 50811-14

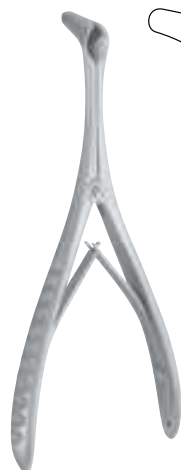

1:2



1:1

Tieck-Halle

135 mm – 5 3/4"

SP 50823-13



Alle Nasenspekula sind optional auch mit Feststellschraube erhältlich

All nasal specula are also available with locking screw

Tous les spéculums nasaux sont aussi disponible avec une vis de fixation

Todos los espejuelos nasales son también disponibles con un tornillo de fijación

Tutti gli speculi nasali sono disponibili anche con vite di fissaggio



if you have any question or are interested in any of the products in this catalog please email info@surgpro.com

Nasenspekula | Spéculums nasaux
Nasal specula | *Espéculos nasales*
 Specoli nasali

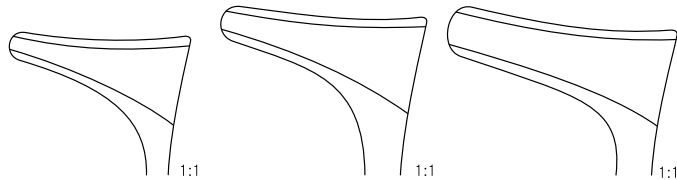
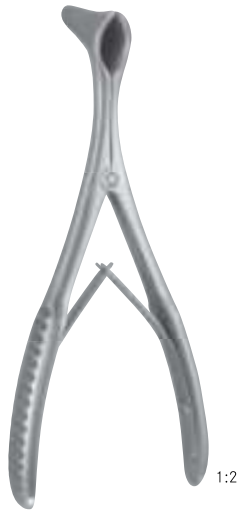

Modell Wien

145 mm - 5 7/8"

	SP 50834-01	SP 50834-02	SP 50834-03
--	--------------------	--------------------	--------------------

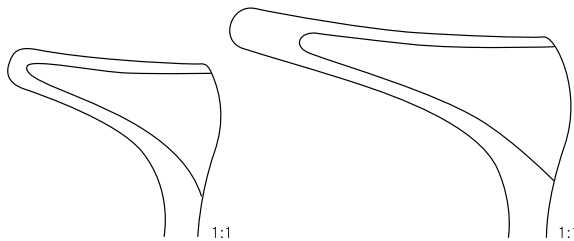
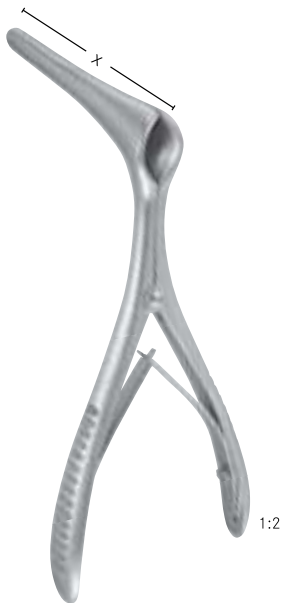

Cottle

	x = 35 mm	x = 50 mm
150 mm - 6"	SP 50836-35	SP 50836-50

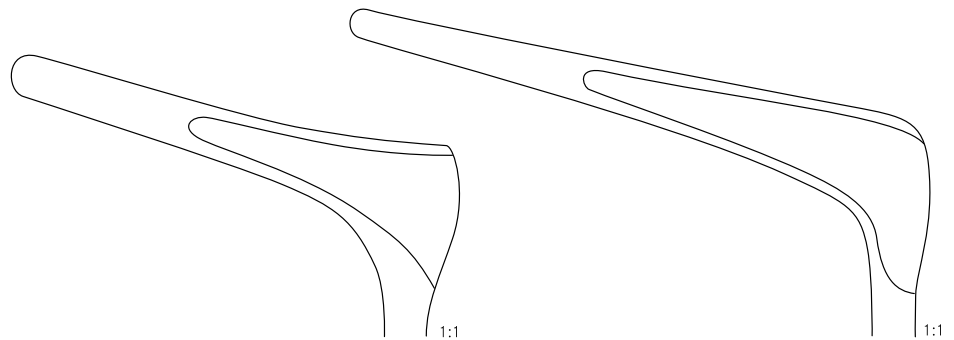

Cottle

	x = 75 mm	x = 90 mm
150 mm - 6"	SP 50836-75	SP 50836-90



if you have any question or are interested in any of the products in this catalog please email info@surgpro.com

Nasenspekula
Nasal specula

Spéculums nasaux
Espéculos nasales
Specoli nasali



1:2

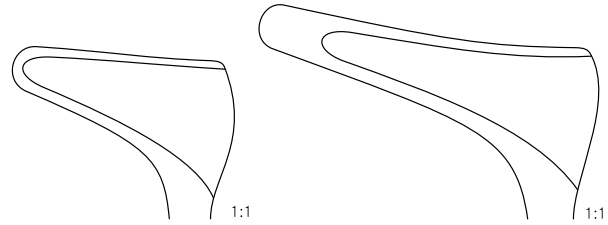

1:1

1:1

Kilian

	x = 35 mm	x = 50 mm
130 mm – 5 "	SP 50828-01	SP 50828-02

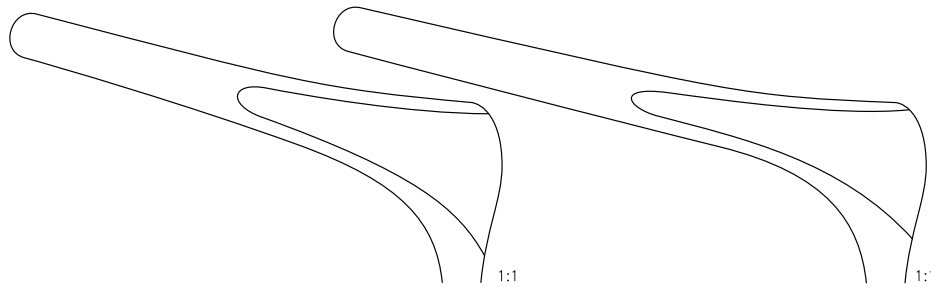

1:1

1:1

	x = 75 mm	x = 90 mm
130 mm – 5 "	SP 50828-03	SP 50828-04



1:1

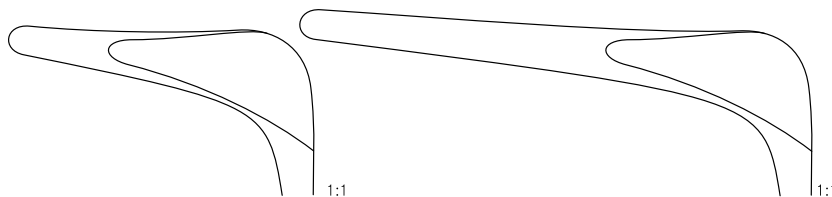

1:1

1:1

Cottle

	x = 45 mm	x = 75 mm
140 mm – 5 1/2 "	SP 50840-45	SP 50840-75

"schwarz verchromt
black, chrome plated
chromé en noir
chromado en negro
cromato nero



if you have any question or are interested in any of the products in this catalog please email info@surgpro.com

Nasensägen | Scies nasales
Nasal saws | Sierras nasales
Seghe nasali

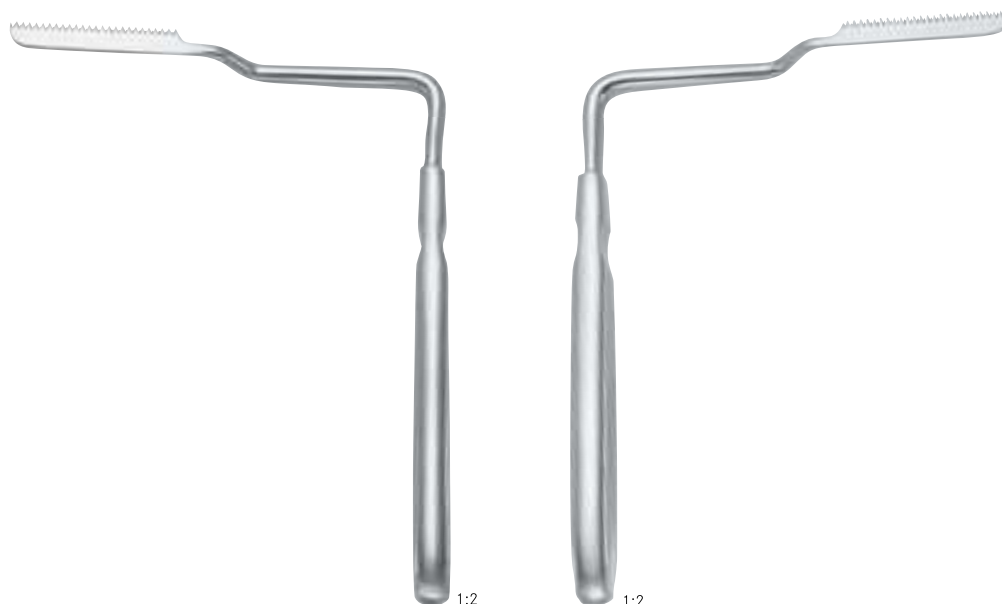

Joseph

170 mm - 6 3/4"

SP 51655-20

SP 51657-20



Joseph

190 mm - 7 1/2"

SP 51661-01

SP 51661-02



if you have any question or are interested in any of the products in this catalog please email info@surgpro.com

Nasenraspeln | Râpes nasales
Nasal rasps | *Limas nasales*
 Raspe nasali



1:2

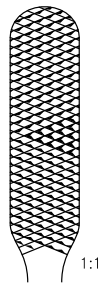

1:1

Aufricht

210 mm - 8¹/₄"

SP 51672-21

auf Zug und auf Stoss schneidend
drawing and pushing cut
 tranchant à traction et en poussant
cortante a tracción y empuje
 tagliente a trazione e a urto



1:2

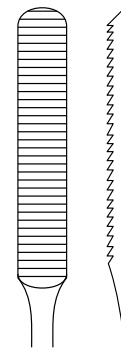

1:1

Cottle

210 mm - 8¹/₄"

SP 51665-21



1:2



1:1



1:1



1:1

Aufricht

210 mm - 8¹/₄"

SP 51669-21

SP 51671-21



if you have any question or are interested in any of the products in this catalog please email info@surgpro.com

Nasenraspeln | Râpes nasales
Nasal rasps | *Limas nasales*
 Raspe nasali

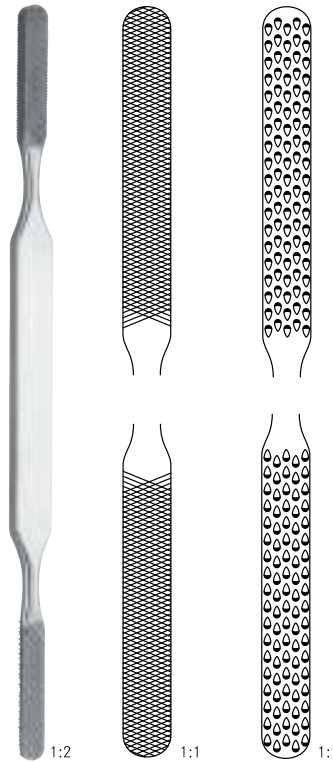

Fomon
 210 mm - 8 1/4"
 " **SP 51685-21**

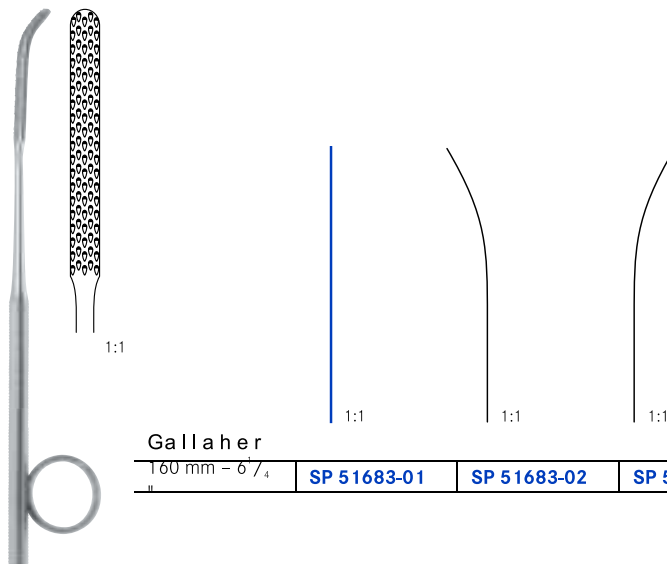

Gallaher
 160 mm - 6 3/4" | **SP 51683-01** | **SP 51683-02** | **SP 51683-03**



if you have any question or are interested in any of the products in this catalog please email info@surgpro.com

Raspeln mit Hartmetall
Rasps with tungsten carbide

Râpes avec inserts de carbure de tungstène
Limas con carburo de tungsteno
Raspe con tungsteno

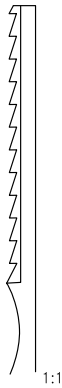

1:1



1:1



1:1



1:1



1:1



1:1

Fig. 1	Fig. 3	Fig. 5	Fig. 7	Fig. 9
12	16	24	36	52

Zähne
Teeth
Dentes
Dientes
Denti

Fomon TC

200 mm - 8"

SP 51686-01 tucar	SP 51686-03 tucar	SP 51686-05 tucar	SP 51686-07 tucar	SP 51686-09 tucar
-----------------------------------	-----------------------------------	-----------------------------------	-----------------------------------	-----------------------------------



1:1



1:1



1:1



1:1



1:1

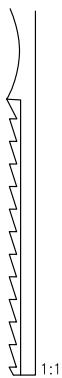

1:1

Fig. 2	Fig. 4	Fig. 6	Fig. 8	Fig. 10
14	20	30	44	62

Zähne
Teeth
Dentes
Dientes
Denti



if you have any question or are interested in any of the products in this catalog please email info@surgpro.com

Septumzangen
Septum forceps

Pinces pour la cloison nasale
Pinzas para el tabique nasal
Pinze per il setto nasale

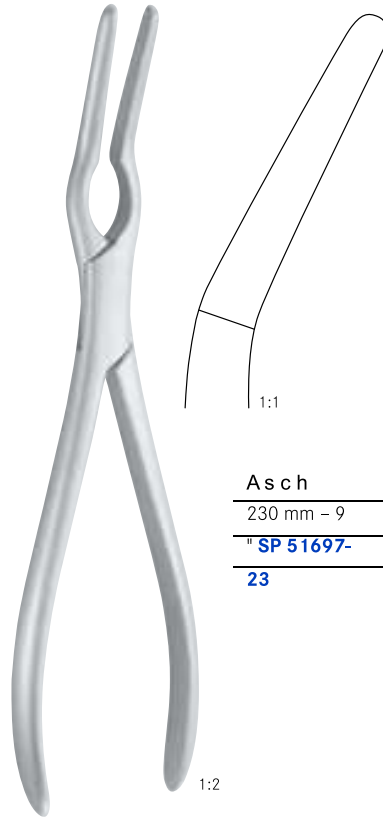

Asch

230 mm - 9

" **SP 51697-**

23



1:2

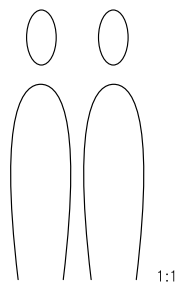

1:1

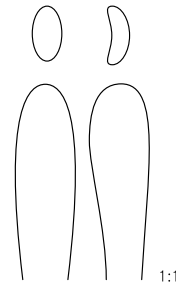

1:1

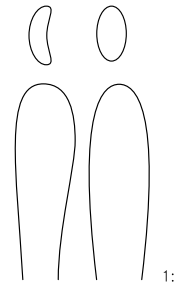

1:1

Cottle-Walsha

230 mm - 9 "

SP 51695-01

SP 51695-02

SP 51695-03

gerade
straight
droit
recta
rette

links
left
gauche
izquierda
a sinistra

rechts
right
droite
derecha
a destra



if you have any question or are interested in any of the products in this catalog please email info@surgpro.com

Septumzangen | Pincas para la cloison nasale
Septum forceps | *Pinzas para el tabique nasal*
 Pinze per il setto nasale

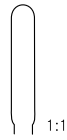

Middleton-Jans
 190 mm – 7½" | **SP 51180-19**



Middleton-Jans
 190 mm – 7½" | **SP 51182-19**

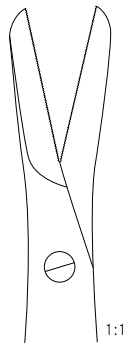

Caplan
 200 mm – 8" | **SP 51184-20**

gezahnt
toothed
 dentelée
 dentado
 dentato

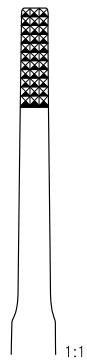

Rubin
 210 mm – 8¼" | **SP 51188-21**



SP 51188-01
 Schutzkappe
Protection Cap
 Capuchon protecteur
 Caperuza protectora
 Calotta protettiva



if you have any question or are interested in any of the products in this catalog please email info@surgpro.com

Sehnenstripper
Tendon strippers

Instruments à écorcher les tendons
Enucleadores de tendones
Scollatendini



	○ 1:1	○ 1:1	○ 1:1
	4.0 mm Ø	4.5 mm Ø	5.5 mm Ø
230 mm – 9 "	SP 24578-40	SP 24578-45	SP 24578-55

Schaft biegsam
Malleable shaft
Tige malléable
Tija maleable
Asta malleabile

1:2



Bunnell	○ 1:1	○ 1:1	○ 1:1
	Fig. 1	Fig. 2	Fig. 3
150 mm – 6 "	SP 24575-01	SP 24575-02	SP 24575-03

○ 1:1	○ 1:1
Fig. 4	Fig. 5
SP 24575-04	SP 24575-05

1:2



if you have any question or are interested in any of the products in this catalog please email info@surgpro.com

Sehnenstripper | Instruments à écorcher les tendons
Tendon strippers | *Enucleadores de tendones*
Scollatendini



Fischer

310 mm – 12 1/4"

SP 24580-31



Bunnell

230 mm – 9"

SP 24582-23

Sehnen durchzugs sonde

Tendon passer

Sonde conductrice pour tendons

Sonda conductora de tendones

Sonda conduttrice per tendini



**Kleinert-
Kutz**

200 mm – 8"

20 mm Ø

SP 24588-20





if you have any question or are interested in any of the products in this catalog please email info@surgpro.com

Sehnenfazzangen
Tendon holding forceps

Pinces pour saisir les tendons
Pinzas para coger tendones
Pinze per afferrare tendini



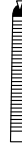

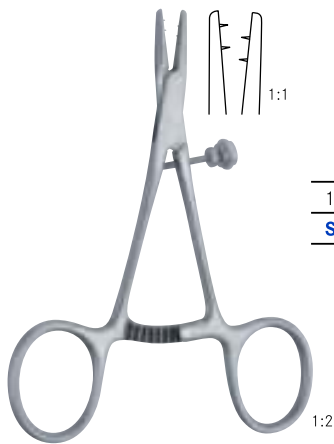
Brand	 1:1	 1:1	 1:1
	150 mm – 6"	190 mm – 7 ¹ / ₂ "	240 mm – 9 ¹ / ₂ "
	SP 24585-15	SP 24585-19	SP 24585-24



 1:1
130 mm – 5"
SP 38724-13



 1:1	 1:1
150 mm – 6"	SP 24589-15
	SP 24590-15



if you have any question or are interested in any of the products in this catalog please email info@surgpro.com

Sehnenfasszangen | Pincès pour saisir les tendons
Tendon holding forceps | *Pinzas para coger tendones*
Pinze per afferrare tendini



205 mm - 8 "

SP 24586-00

SP 24586-01

Sehnedurchzugszange

Tendon passer

Pince conductrice pour tendons

Pinza conductora para tendones

Pinza conduttrice per tendini



Ca r o l l

110 mm - 4¼ "

SP 38723-11

Sehnenfaßzange

Tendon grasping forceps

Pince pour saisir les tendons

Pinza para coger tendones

Pinza per afferrare tendini



if you have any question or are interested in any of the products in this catalog please email info@surgpro.com

Hohlmeißelzangen | Pincés gougés
Bone rongeurs | *Pinzas gubias*
 Pinze sgorbie

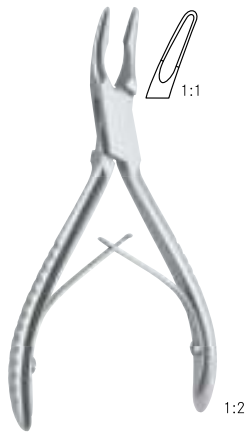

Mini-Friedman
 120 mm – 4³/₄"
 " **SP 24605-12**



Friedman
 140 mm – 5¹/₂"
 " **SP 24605-14**

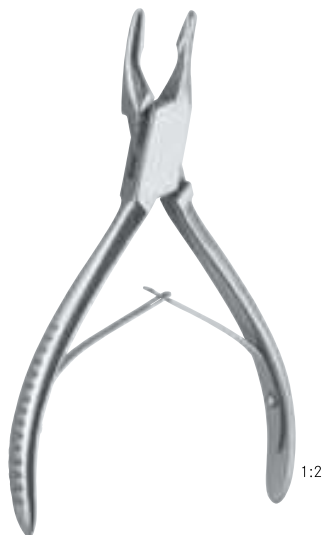

Blumentha

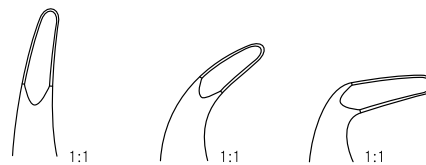
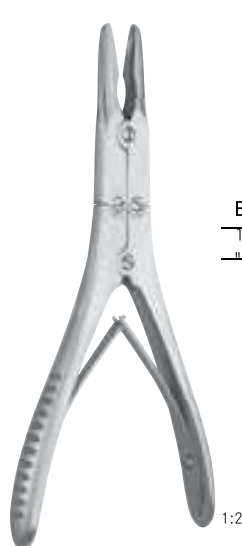

	Fig. 1	Fig. 2	Fig. 3
155 mm – 6"	SP 24606-01	SP 24606-02	SP 24606-03



if you have any question or are interested in any of the products in this catalog please email info@surgpro.com

Hohlmeißelzangen | Pincés gouges
Bone rongeurs | *Pinzas gubias*
 Pinze sgorbie



Böhler

150 mm - 6"



1:1



1:1

	SP 246 13-00	SP 246 13-02
--	---------------------	---------------------



Stellbrink

175 mm - 7"



1:1

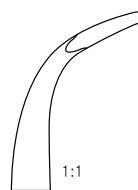

1:1

	SP 246 14-01	SP 246 14-02
--	---------------------	---------------------

leicht gebogen
slightly curved
 légèrement courbe
ligeramente curvada
 legermente curvata

stark gebogen
strongly curved
 très courbe
fuertemente curvada
 fortemente curvata



if you have any question or are interested in any of the products in this catalog please email info@surgpro.com

Hohlmeißelzangen | Pincés gougés
Bone rongeurs | *Pinzas gubias*
 Pinze sgorbie

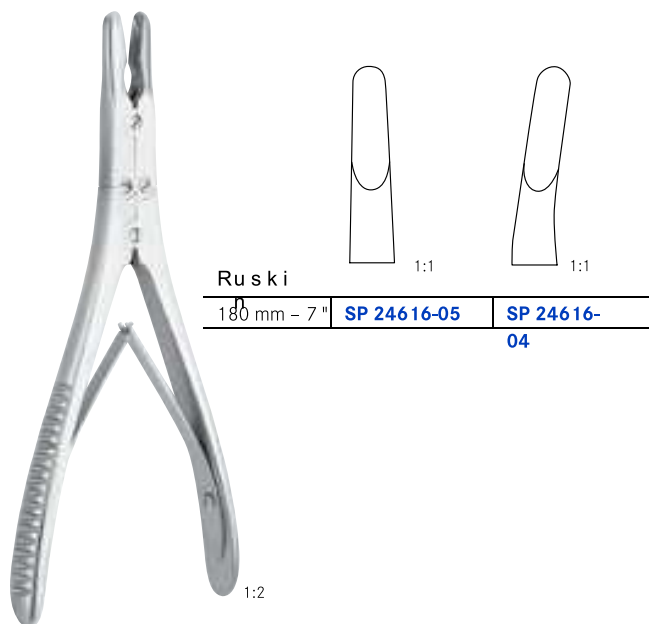
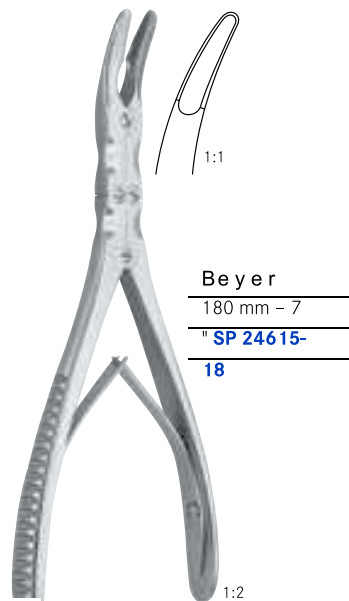
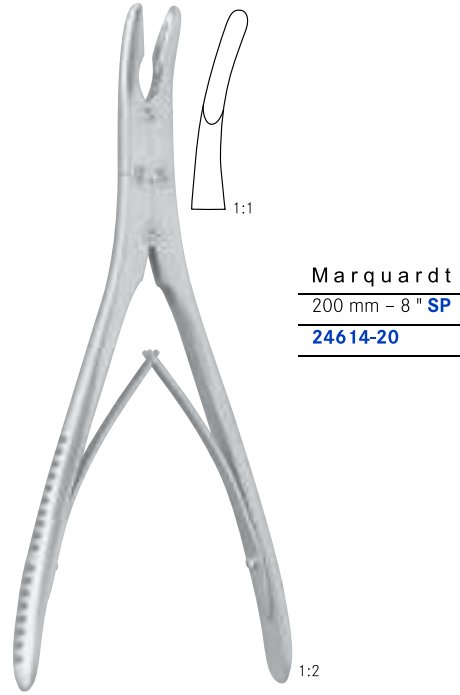

if you have any question or are interested in any of the products in this catalog please email info@surgpro.com

Knochensplitterzangen | Pincas coupantes à os
Bone cutting forceps | *Pinzas cortantes para huesos*
 Cesioie per ossa

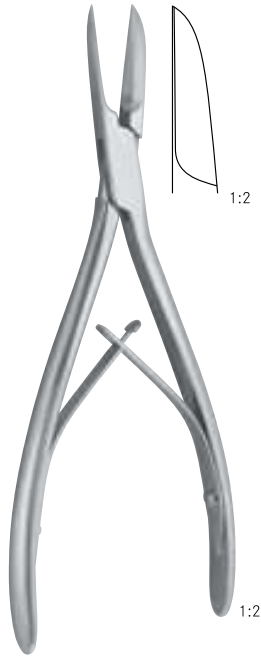

Cottle-Cazanja
 n
 190 mm - 7 1/2"
 " **SP 24649-19**



Böhler
 150 mm - 6"
 " **SP 24654-15** | **SP 24655-15**



Ruskin-Listo
 185 mm - 7 3/4"
 " **SP 24660-18** | **SP 24661-18**

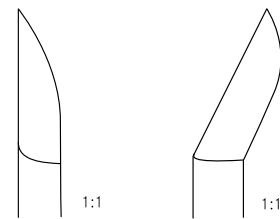

if you have any question or are interested in any of the products in this catalog please email info@surgpro.com

Tränenkanal-Dilatatoren
Lacrimonal dilators

Dilatateurs pour le canal lacrymal
Dilatadores para el canal lacrimonal
Dilatatori lacrimonali

Tränenkanal-Dilatator

Lacrimonal dilators

Dilatateurs pour le canal lacrymal

Dilatadores para el canal lacrimonal

Dilatatori lacrimonali



Bowma

Fig. 000 / 00	Fig. 00 / 0	Fig. 0 / 1	Fig. 1 / 2	Fig. 2 / 3
0.4 / 0.6 mm Ø	0.7 / 0.8 mm Ø	0.8 / 0.9 mm	0.9 / 1.1 mm	1.1 / 1.3 mm
SP 40099-00	SP 40100-00	Ø SP 40100-	Ø SP 40100-	Ø SP 40100-
		01	12	23
Fig. 3 / 4	Fig. 4 / 5	Fig. 5 / 6	Fig. 6 / 7	Fig. 7 / 8
1.3 / 1.4 mm	1.4 / 1.5 mm	1.5 / 1.6 mm	1.6 / 1.8 mm	1.8 / 1.9 mm
Ø SP 40100-	Ø SP 40100-	Ø SP 40100-	Ø SP 40100-	Ø SP 40100-
34	45	56	67	78

34 zylindrisch

cylindrical

cylindriques

cilíndrico

cilindrico



Williams

Fig. 000 / 00	Fig. 00 / 0	Fig. 0 / 1	Fig. 1 / 2	Fig. 2 / 3
0.4 / 0.6 mm Ø	0.7 / 0.8 mm Ø	0.8 / 0.9 mm	0.9 / 1.1 mm	1.1 / 1.3 mm
SP 40101-00	SP 40102-00	Ø SP 40102-	Ø SP 40102-	Ø SP 40102-
		01	12	23
Fig. 3 / 4	Fig. 4 / 5	Fig. 5 / 6	Fig. 6 / 7	Fig. 7 / 8
1.3 / 1.4 mm	1.4 / 1.5 mm	1.5 / 1.6 mm	1.6 / 1.8 mm	1.8 / 1.9 mm
Ø SP 40102-	Ø SP 40102-	Ø SP 40102-	Ø SP 40102-	Ø SP 40102-
34	45	56	67	78

34 geknöpft

probe

boutonnés

botonado

botonuti



if you have any question or are interested in any of the products in this catalog please email info@surgpro.com

Tränenkanal-Dilatatoren
Lacrimonal dilators

Dilatateurs pour le canal lacrymal
Dilatadores para el canal lacrimonal
Dilatatori lacrimonali



115 mm - 4 1/2 "	SP 18110-11	SP 18112-11
130 mm - 5 "	SP 18110-13	SP 18112-13
145 mm - 5 3/4 "	SP 18110-14	SP 18112-14
160 mm - 6 1/4 "	SP 18110-16	SP 18112-16
180 mm - 7 "	SP 18110-18	SP 18112-18
200 mm - 8 "	SP 18110-20	SP 18112-20

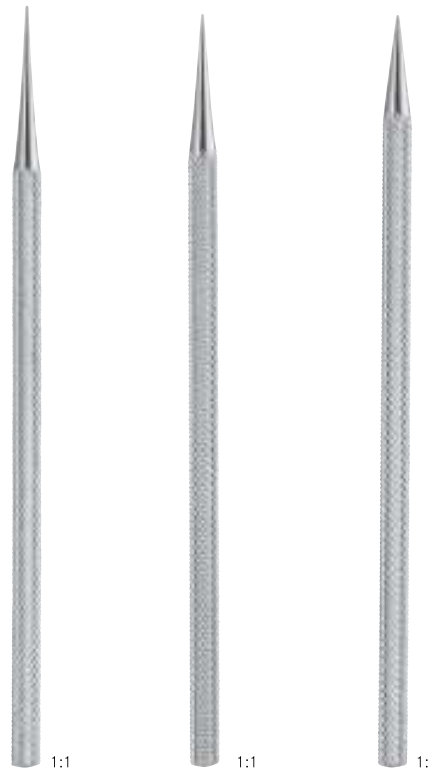

Wilder

SP 40105-00	SP 40106-00	SP 40107-00
-----------------------------	-----------------------------	-----------------------------

Tränenkanal-Dilatatoren
Lacrimonal dilators

Dilatateurs pour le canal lacrymal
Dilatadores para el canal lacrimonal
Dilatatori lacrimonali



if you have any question or are interested in any of the products in this catalog please email info@surgpro.com

Knorpelquetscher | Broyeurs pour os
Bone crusher | *Prensas para huesos*
Trittatori osseo



Cottle

SP 51648-00

Quetscher mit Klammer
bone crusher with clamp
broyeur avec pince
prensa para huesos
sciaccia cartilagine



SP 51755-00

Knorpelhalter
cartilage holding forceps
pince à saisir des
cartilages *pinza para tener*
cartilagos pinza fi ssa
cartilagine



Cottle

SP 51649-00

Knochenmühle
bone mill
moulin d'os
molino de huesos
mulino per ossa



if you have any question or are interested in any of the products in this catalog please email info@surgpro.com

Instrumenten-Kassetten aus Edelstahl Instrument trays made of stainless steel

Contenaires d'instruments en acier inox
Cajas en acero inox para instrumental
Scatole per sterilizzazione di acciaio inossidabile



Mit Deckel- und Bodenlochung mit Textil-Langzeitfiltern für Dampfsterilisation
With lid and bottom perforation with textil "Longterm" filters for steam sterilisation
Couvercle et boîtier perforé avec filtre en textile pour stérilisation à vapeur
Con perforación en tapa y fondo, con filtros en tejido para esterilización a vapor
Con filtri tessili, per la sterilizzazione a vapore

Silikon-Andrückleisten zum Fixieren der Instrumente
Silicone protective strips for fixation of instruments Tapis en silicone pour fixer les instruments
Tiras de silicon para fijar los instrumentos
Righe di silicone per fissare gli strumenti

Silikon-Noppenstreifen zur schonenden Auflage der Instrumente
Silicone strips for a soft and protective storage of the instruments
Tapis en silicone pour la protection des instruments
Mata de silicon para proteger los instrumentos
Stuoie di silicone per proteggere gli strumenti

1 herausnehmbare Siebplatte
1 removable tray insert
1 tableau pour sortir
1 placa para sacar
1 cestello

Kennzeichnungsschilder nach Wahl (Farbe und Text)
Marking plate for selection: colour and description
Plaquette d'identification (texte et couleur selon demande)
Placas de identificación a opción (color y texto)
Placche d'identificazione (colore a scelta)

280 x 195 x 55 mm	265 x 255 x 55 mm	380 x 260 x 55 mm	200 x 140 x 55 mm	470 x 250 x 55 mm
SP 85100-01	SP 85101-01	SP 85102-01	SP 85103-01	SP 85104-01



wärmeisolierende Halteknöpfe zum Herausheben
heatisolated handles
pins isolés pour sortir des tableaux
Pernos aislados para sacar las placas
maniglia a forma di botone

2 herausnehmbare Siebplatten
2 removable tray inserts
2 tableaux detachables
2 placas para sacar
2 cestelli

Silikon-Andrückleisten an der Unterseite des Siebes
Silicone protective strips at the lower side of the tray Tapis de silicone à la partie inférieure des tableaux
Tiras de silicon a bajo de las placas
Righe di silicone

280 x 195 x 65 mm	265 x 255 x 65 mm	380 x 260 x 65 mm	200 x 140 x 65 mm	470 x 250 x 65 mm
SP 85100-03	SP 85101-03	SP 85102-03	SP 85103-03	SP 85104-03



if you have any question or are interested in any of the products in this catalog please email info@surgpro.com

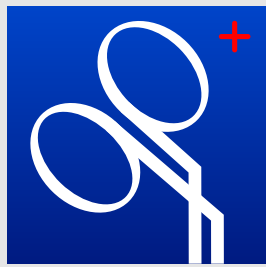

SURGPRO